

5A SURFACE MOUNT SCHOTTKY BRIDGE RECTIFIER

Reverse Voltage - 60 V

Forward Current – 5A

FEATURES

- ◆High current capability
- ◆Low forward voltage drop
- ◆Designed for Surface Mount Application
- ◆Low power loss, high efficiency
- ◆Lead free in comply with EU RoHS 2011/65/EU directives

MECHANICAL DATA

- ◆Case: UMSB
- ◆Terminals: Solderable per MIL-STD-750, Method 2026
- ◆Approx. Weight: 233.7mg /0.00824oz

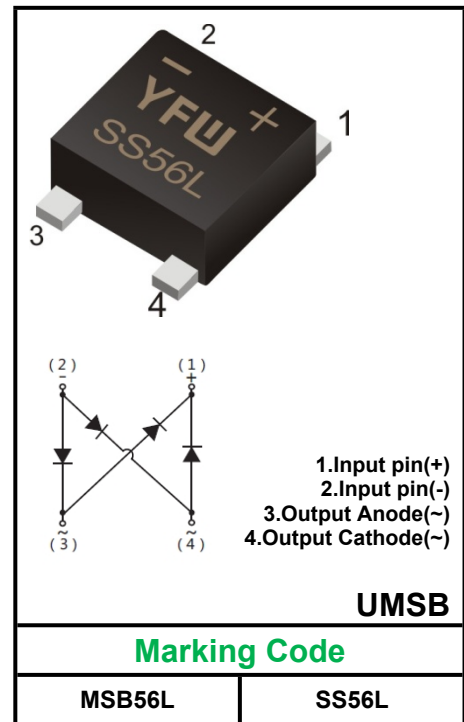

Maximum Ratings and Electrical characteristics

Ratings at 25 °C ambient temperature unless otherwise specified.

Single phase half-wave 60 Hz, resistive or inductive load, for capacitive load current derate by 20 %.

Parameter	Symbols	MSB56L	Units
Maximum Repetitive Peak Reverse Voltage	V_{RRM}	60	V
Maximum RMS voltage	V_{RMS}	42	V
Maximum DC Blocking Voltage	V_{DC}	60	V
Average Rectified Output Current	I_o	5.0	A
Peak Forward Surge Current 8.3 ms Single Half Sine-Wave Superimposed on Rated Load(JEDEC method)	I_{FSM}	80	A
Forward Voltage per element @ $I_F=3A$ @ $I_F=5A$	V_F	0.45(TYP) 0.59	V
Maximum DC Reverse Current at Rated DC Blocking Voltage @ $T_A=25^{\circ}C$	I_R	0.3	mA
Typical Junction Capacitance (Note1)	C_j	300	pF
Operating and Storage Temperature Range	T_j, T_{stg}	-55 ~ +150	°C

(1) Measured at 1 MHz and applied reverse voltage of 4 V D.C

(2) Mounted on glass epoxy PC board with 4×1.5"×1.5" (3.81×3.81 cm) copper pad.

Fig.1 Average Rectified Output Current Derating Curve

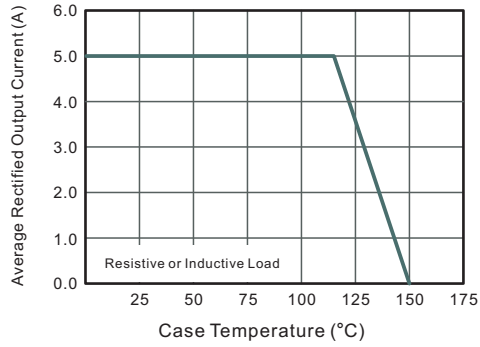

Fig.2 Typical Reverse Characteristics

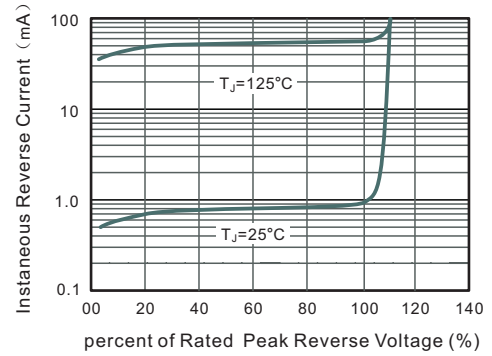

Fig.3 Typical Instantaneous Forward Characteristics

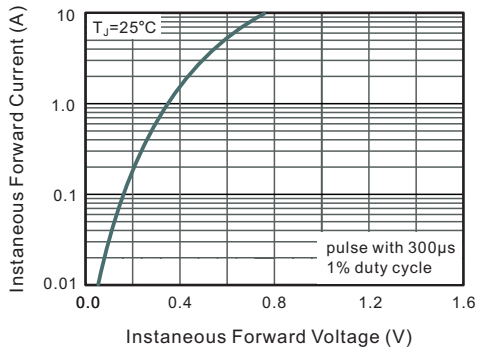

Fig.4 Typical Junction Capacitance

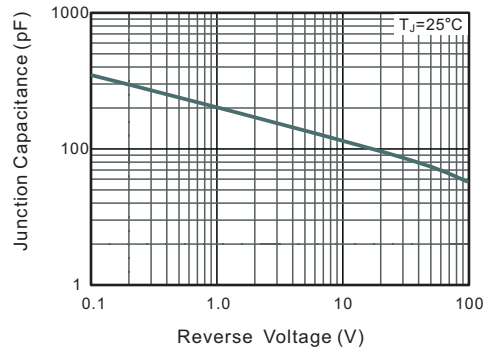
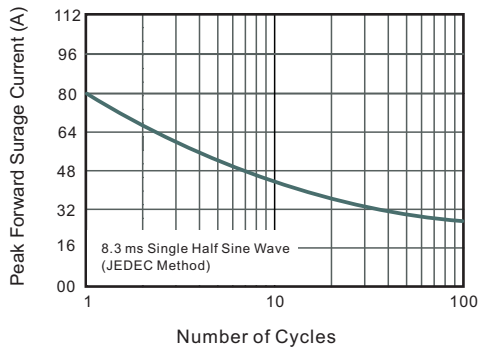
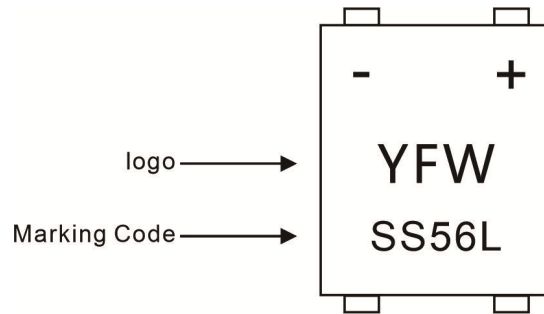

Fig.5 Maximum Non-Repetitive Peak Forward Surge Current



Marking Diagram



Ordering information

Package	Packing Description	Packing Quantity
UMSB	Tape/Reel, 13" reel	3000PCS/Reel 30000PCS/Carton

Package Dimensions

UMSB

Dim.	Millimeter(mm)		(mil)	
	Min.	Max.	Min.	Max.
A	1.3	1.5	51	59
C	0.17	0.29	7	12
D	6.2	7.0	244	276
E	7.1	7.6	280	299
E ₁	8.4	8.9	331	350
L	1.0	1.6	31.5	55
e	4.9	5.3	193	209
b	0.95	1.15	37	45
∠	10°			

The recommended mounting pad size

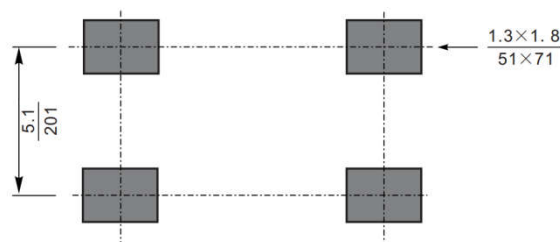

Unit: $\frac{\text{mm}}{(\text{mil})}$

Disclaimer

The information presented in this document is for reference only. GuangDong Youfeng Microelectronics Co.,Ltd. reserves the right to make changes without notice for the specification of the products displayed herein to improve reliability, function or design or otherwise. The product listed herein is designed to be used with ordinary electronic equipment or devices, and not designed to be used with equipment or devices which require high level of reliability and the malfunction of which would directly endanger human life (such as medical instruments, transportation equipment, aerospace machinery, nuclear-reactor controllers, fuel controllers and other safety devices), YFW or anyone on its behalf, assumes no responsibility or liability for any damages resulting from such improper use of sale. This publication supersedes & replaces all information previously supplied. For additional information, please visit our website <https://www.yfwdiode.com>, or consult YFW sales office for further assistance.