

1.0A SURFACE MOUNT GLASS PASSIVATED BRIDGE

RECTIFIER Reverse Voltage - 100 to 1000 V

Forward Current – 1.0A

FEATURES

- ◆Fast reverse recovery time
- ◆Designed for Surface Mount Application
- ◆Glass Passivated Chip Junction
- ◆Low power loss, high efficiency
- ◆Lead free in comply with EU RoHS 2011/65/EU directives

MECHANICAL DATA

- ◆Case: ABS/LBF
- ◆Terminals: Solderable per MIL-STD-750, Method 2026
- ◆Approx. Weight: 88mg / 0.0031oz

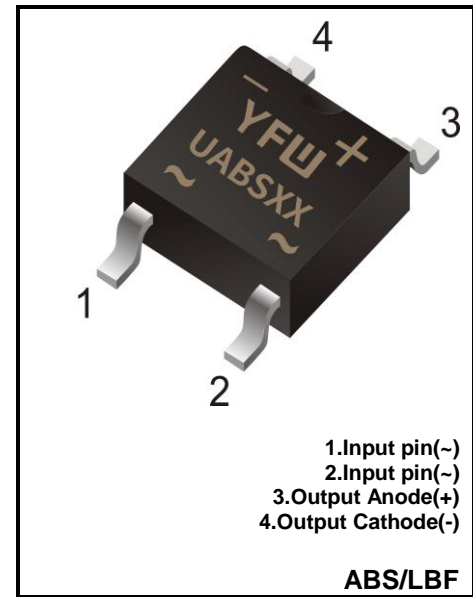

Maximum Ratings and Electrical characteristics

Ratings at 25 °C ambient temperature unless otherwise specified.

Single phase half-wave 60 Hz, resistive or inductive load, for capacitive load current derate by 20 %.

Parameter	Symbols	UABS1	UABS2	UABS4	UABS6	UABS8	UABS10	Units
Maximum Repetitive Peak Reverse Voltage	V_{RRM}	100	200	400	600	800	1000	V
Maximum RMS voltage	V_{RMS}	70	140	280	420	560	700	V
Maximum DC Blocking Voltage	V_{DC}	100	200	400	600	800	1000	V
Average Rectified Output Current at $T_c = 125\text{ }^\circ\text{C}$	I_o	1.0						A
Peak Forward Surge Current 8.3 ms Single Half Sine-Wave Superimposed on Rated Load (JEDEC method)	I_{FSM}	35						A
Forward Voltage per element at 1.0A	V_F	1.0		1.3		1.5		V
Maximum DC Reverse Current @ $T_A=25\text{ }^\circ\text{C}$ at Rated DC Blocking Voltage @ $T_A=125\text{ }^\circ\text{C}$	I_R	5.0 100						μA
Typical Junction Capacitance ^(Note1)	C_j	18						pF
Maximum Reverse Recovery Time ^(Note2)	T_{RR}	50			75			nS
Typical Thermal Resistance ^(Note3)	$R_{\theta JA}$ $R_{\theta JC}$	72 20						$^\circ\text{C/W}$
Operating and Storage Temperature Range	T_j, T_{stg}	-55 ~ +150						$^\circ\text{C}$

(1) Measured at 1 MHz and applied reverse voltage of 4 V D.C

(2) Mounted on glass epoxy PC board with 4x1.5"x1.5" (3.81x3.81 cm) copper pad.

Fig.1 Reverse Recovery Time Characteristic And Test Circuit Diagram

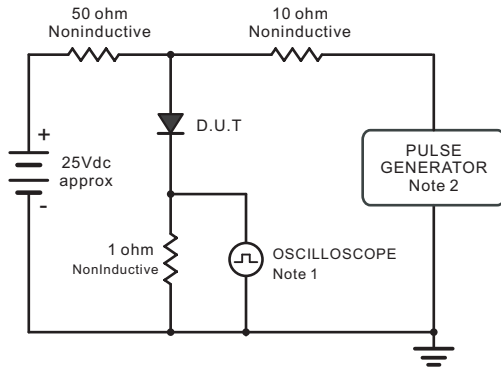

Note: 1. Rise Time = 7ns, max.
Input Impedance = 1megohm, 22pF.
2. Rises Time = 10ns, max.
Source Impedance = 50 ohms.

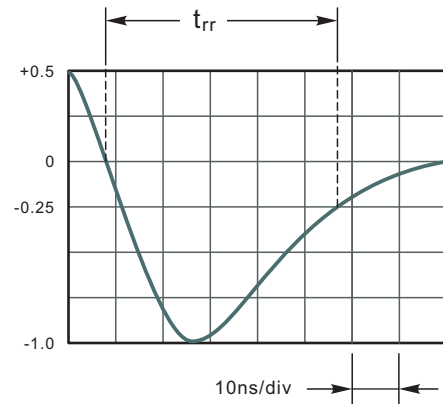

Set time Base for 10ns/div

Fig.2 Maximum Average Forward Current Rating

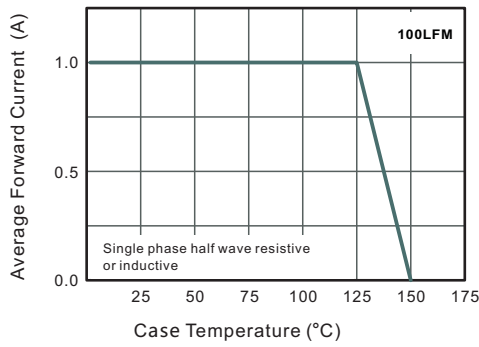

Fig.3 Typical Reverse Characteristics

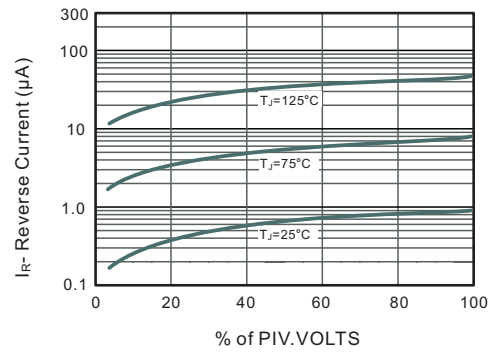

Fig.3 Typical Instaneous Forward Characteristics

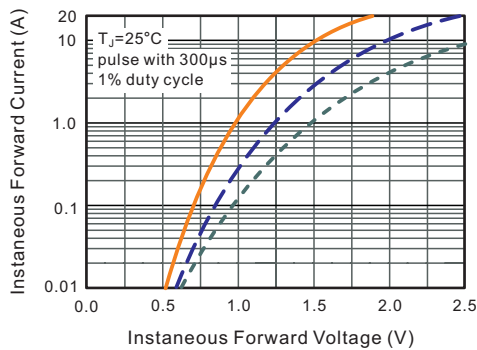
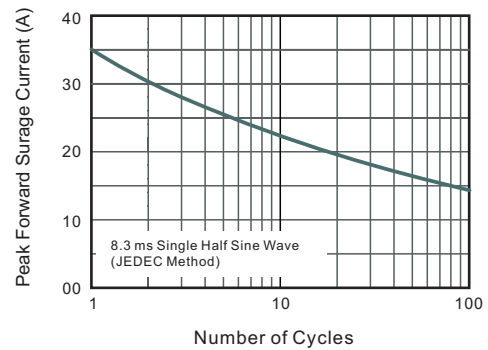
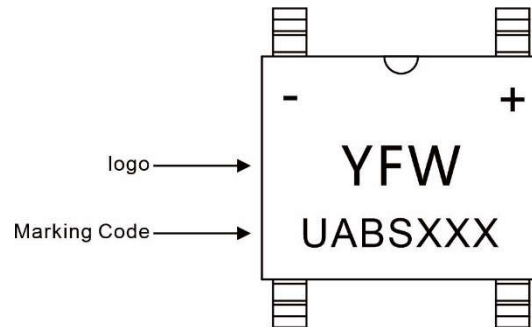

Fig.4 Maximum Non-Repetitive Peak Forward Surge Current



Marking Diagram



Ordering information

Package	Packing Description	Packing Quantity
ABS(LBF)	Tape/Reel, 13" reel	5000PCS/Reel 50000PCS/Carton

Package Dimensions

ABS(LBF)

Dim.	Millimeter(mm)		(mil)	
	Min.	Max.	Min.	Max.
A	1.3	1.5	51	59
C	0.15	0.22	5.9	8.7
D	4.9	5.2	193	205
E	4.2	4.5	166	177
HE	6.0	6.4	236	252
d	3.8	4.2	150	165
e	0.5	0.7	20	28
L	0.95		37	
L1	0.6		24	
a	0.2		8	
∠	7°			

The recommended mounting pad size

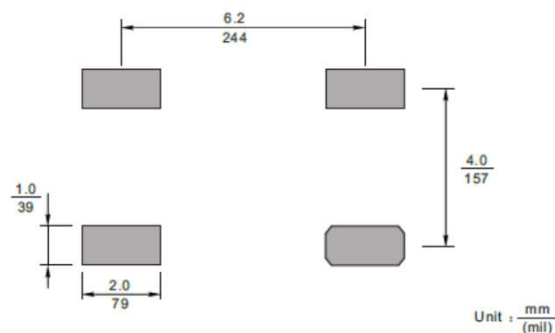

Disclaimer

The information presented in this document is for reference only. Guangdong Youfeng Microelectronics Co.,Ltd. reserves the right to make changes without notice for the specification of the products displayed herein to improve reliability, function or design or otherwise. The product listed herein is designed to be used with ordinary electronic equipment or devices, and not designed to be used with equipment or devices which require high level of reliability and the malfunction of which would directly endanger human life (such as medical instruments, transportation equipment, aerospace machinery, nuclear-reactor controllers, fuel controllers and other safety devices), YFW or anyone on its behalf, assumes no responsibility or liability for any damages resulting from such improper use of sale. This publication supersedes & replaces all information previously supplied. For additional information, please visit our website <https://www.yfwdiode.com>, or consult YFW sales office for further assistance.