

High Efficiency Rectifiers

Reverse Voltage - 200V

Forward Current - 40A

Features

- ◆ Glass passivated chip junctions
- ◆ High Speed recovery time for switching mode application
- ◆ High Forward Surge Capability
- ◆ Low Reverse Current
- ◆ Lead free in compliance with EU RoHS 2011/65/EU directive

Mechanical Data

- ◆ Leads: Solderable per mil-std-202, Method 208
- ◆ Polarity: as marked
- ◆ Mounting torque: 5 in-lbs maximum
- ◆ Terminals: Puretin plated

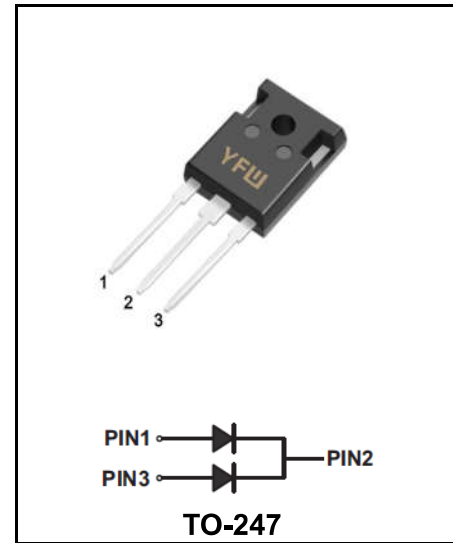

Maximum Ratings & Electrical Characteristics

Rating	Symbol	Value	Unit
Maximum Repetitive Reverse Voltage	V_{RRM}	200	V
Maximum RMS voltage	V_{RMS}	140	V
DC Blocking Voltage	V_{DC}	200	V
Average Forward Current per device per diode	I_F	40 20	A
Max.Forward Surge Current ,8.3ms single half sine-wave superimposed on rated load	I_{FSM}	500	A
Typical Forward Voltage at $I_F=20A$	V_F	1.0	V
Max. DC Reverse Current at Rated DC Blocking Voltage	I_R	5 250	μA
Typical Reverse Recovery Time (Note 1)	T_{RR}	50	nS
Typical Thermal Resistance(Note 2)	$R_{\theta-JC}$	1.5	$^{\circ}C/W$
Operating Junction Temperature Range	T_J	-55 to +150	$^{\circ}C$
Storage Temperature Range	T_{STG}	-55 to +150	$^{\circ}C$

NOTES:

1. Reverse Recovery Test Conditions: $I_F=0.5A$, $I_R=1A$, $I_{rr}=0.25A$.
2. Thermal resistance from junction to case.

Ratings and Characteristic Curves

FIG. 1 - TYPICAL FORWARD CURRENT DERATING CURVE

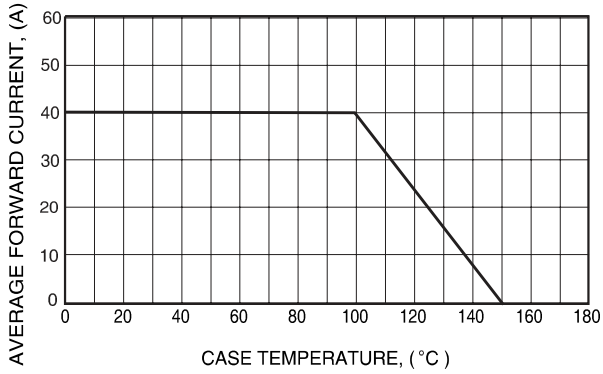

FIG. 2 - MAXIMUM NON-REPETITIVE FORWARD SURGE CURRENT

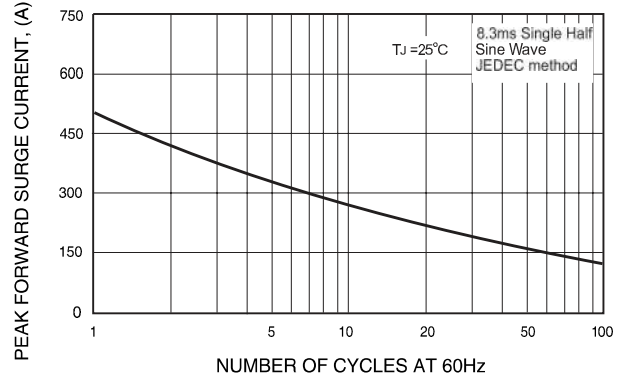

FIG. 3 - TYPICAL REVERSE CHARACTERISTICS

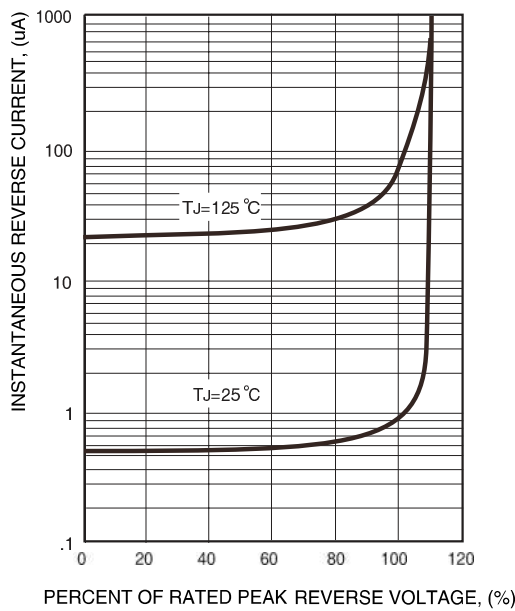
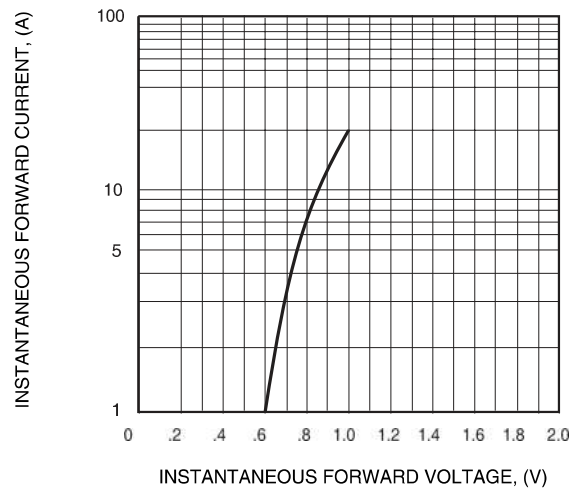
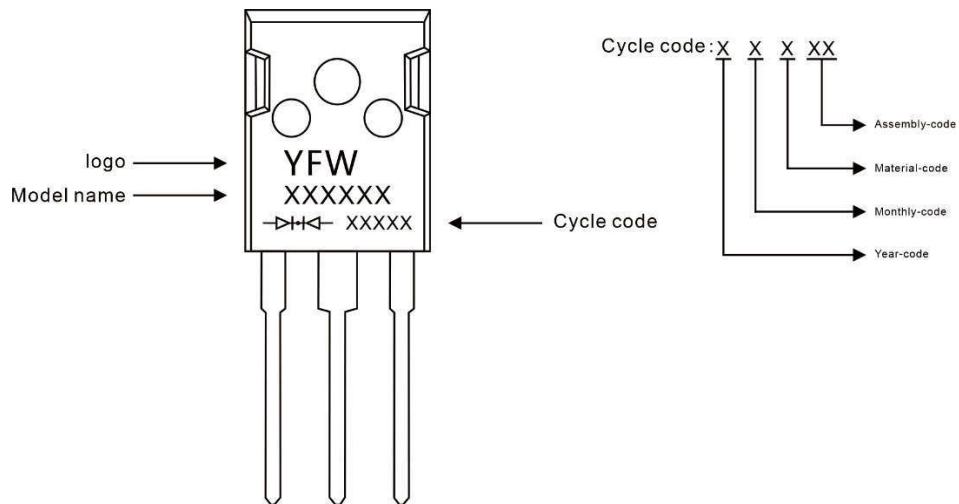

FIG. 4 - TYPICAL INSTANTANEOUS FORWARD CHARACTERISTICS



Marking Diagram



Ordering information

Model name	Package	Unit Weight	Base Quantity	Packing Quantity
MUR4020SPT	TO-247	0.209oz(5.93g)	30pcs/tube	600PCS/Box 2400PCS/Carton

Package Dimensions

TO-247

Symbol	Dimensions in mm		Dimensions in Inch	
	Min.	Max.	Min.	Max.
A	4.90	5.10	0.193	0.201
A1	1.90	2.10	0.075	0.083
A2	2.29	2.54	0.090	0.100
b	1.00	1.40	0.039	0.055
b1	2.00	2.20	0.079	0.087
b2	3.00	3.20	0.118	0.126
c	0.50	0.70	0.020	0.028
D	15.75	16.05	0.620	0.632
E	20.20	20.80	0.795	0.819
e	5.45 (BSC)		0.215 (BSC)	
e1	10.90 (BSC)		0.429 (BSC)	
F	6.05	6.25	0.238	0.246
F1	5.80	6.00	0.228	0.236
L	20.10	20.40	0.791	0.803
L1	4.05	4.35	0.159	0.171
Φ	3.50	3.70	0.138	0.146

Disclaimer

The information presented in this document is for reference only. Guangdong Youfeng Microelectronics Co.,Ltd. reserves the right to make changes without notice for the specification of the products displayed herein to improve reliability, function or design or otherwise. The product listed herein is designed to be used with ordinary electronic equipment or devices, and not designed to be used with equipment or devices which require high level of reliability and the malfunction of which would directly endanger human life (such as medical instruments, transportation equipment, aerospace machinery, nuclear-reactor controllers, fuel controllers and other safety devices), YFW or anyone on its behalf, assumes no responsibility or liability for any damages resulting from such improper use of sale. This publication supersedes & replaces all information previously supplied. For additional information, please visit our website <https://www.yfwdiode.com>, or consult YFW sales office for further assistance.