

1 Channel Ultra-low Capacitance ESD Protection

Features

- ◆ Ultra-Low capacitance: 0.05pF(typ.)
- ◆ Low leakage current (<100nA)
- ◆ Fast response time (<1ns)
- ◆ Bi-directional, single line protection
- ◆ IEC 61000-4-2 (ESD Air): 15kV
- ◆ IEC 61000-4-2 (ESD Contact): 8kV

Application

- ◆ USB 3.0/3.1
- ◆ HDMI 1.3/1.4/2.0
- ◆ RF Antenna
- ◆ SATA and eSATA Interface

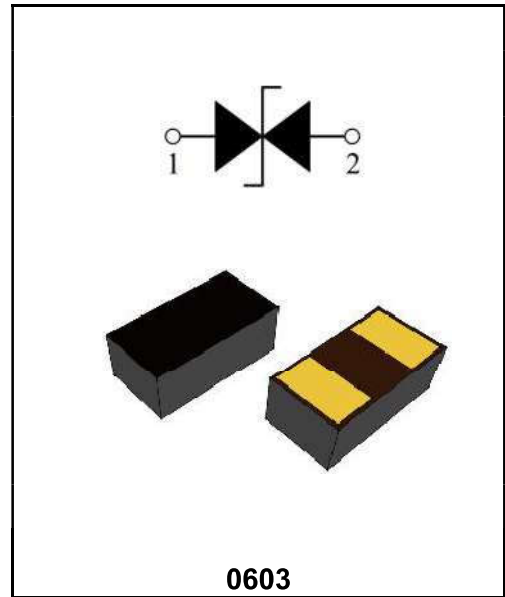

Order Information

| Part Number | Package | Size (mm) | Delivery Form | Delivery Quantity |
|-------------|---------|----------------|---------------|-------------------|
| PESD0603B24 | 0603 | 1.60X0.80X0.40 | 7" T&R | 5000PCS/Tape |

Limiting Values(TA = 25 °C, unless otherwise specified)

| Symbol | Parameter | Conditions | Min | Max | Unit |
|--------|---------------------------------|----------------------------------|-----|-----|------|
| VESD | Electrostatic Discharge Voltage | IEC 61000-4-2; Contact Discharge | - | 8 | kV |
| | | IEC 61000-4-2; Air Discharge | - | 15 | kV |
| TA | Operating Temperature Range | - | -40 | 90 | °C |
| Tstg | Storage Temperature Range | - | -55 | 125 | °C |

Electrical Characteristics(TA = 25 °C unless otherwise specified)

| Symbol | Parameter | Conditions | Min | Typ. | Max | Unit |
|--------|------------------------------|---------------------------------------|-----|------|------|------|
| VDC | Continuous Operating Voltage | - | - | - | 24.0 | V |
| VT | Trigger Voltage | IEC61000-4-2 8kV contact discharge | - | 450 | - | V |
| VC | Clamping Voltage | IEC61000-4-2 8kV contact discharge | - | 40 | - | V |
| IL | Leakage Current | DC 24 V shall be applied on component | - | - | 100 | nA |
| CJ | Capacitance | Measured at 10MHz | - | 0.05 | - | pF |

Typical Characteristics

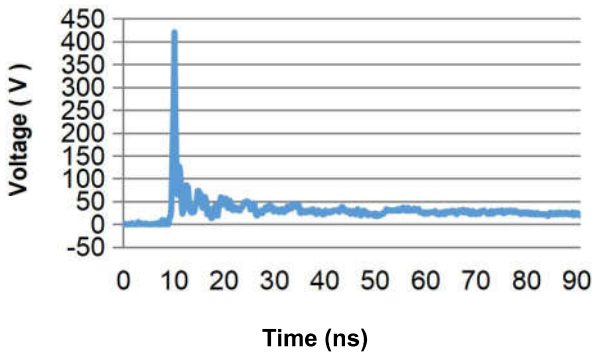

Fig.1 Typical ESD Response (IEC 61000-4-2, 8kV contact discharg)

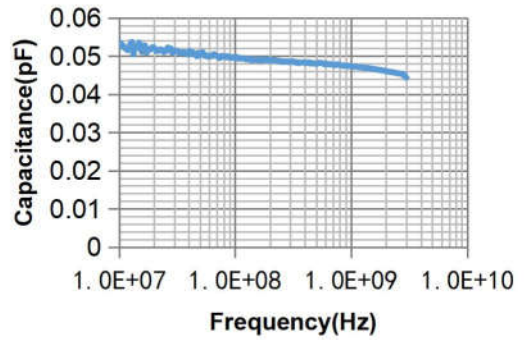
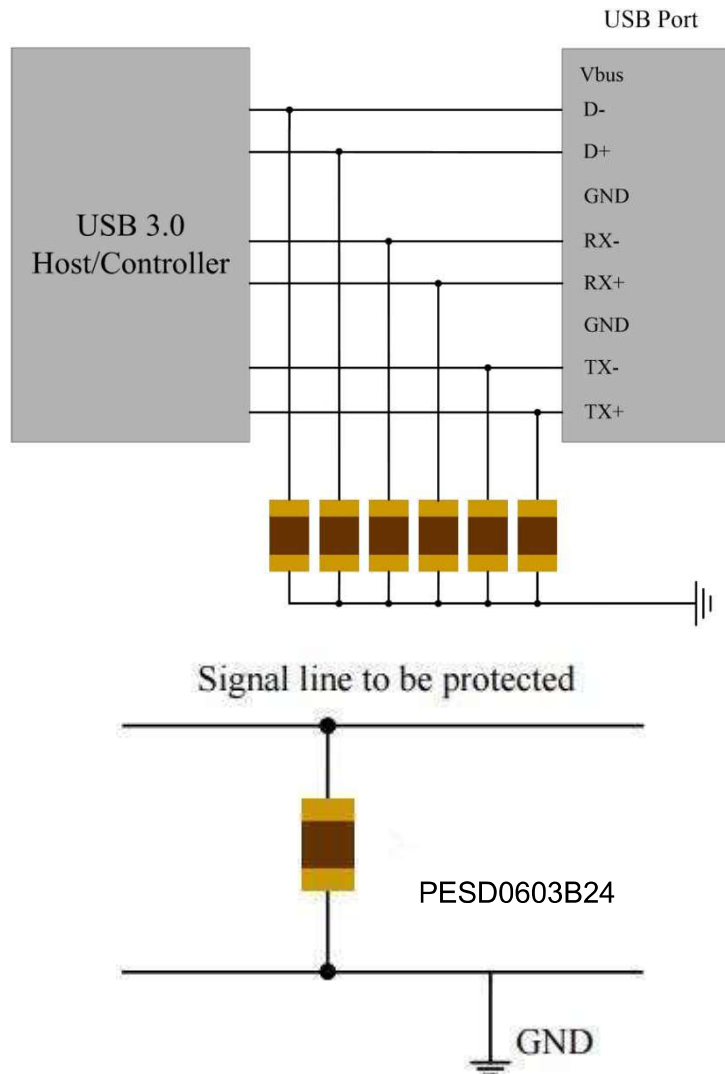

Fig.2 Typical Device Capacitance VS. Frequency

ESD Protection for Signal Line

The PESD is designed for the protection of one bidirectional data line from ESD damage.

1. Place the PESD as close to the input terminal or connector as possible.
2. Minimize the path length between the PESD and the protected signal line.
3. Use ground planes whenever possible.



Package Dimension

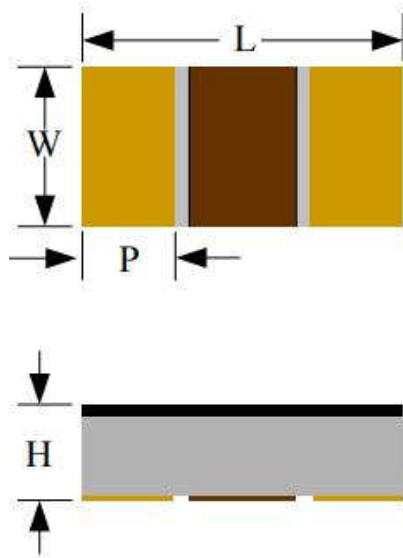

Recommended Solder Pad Footprint

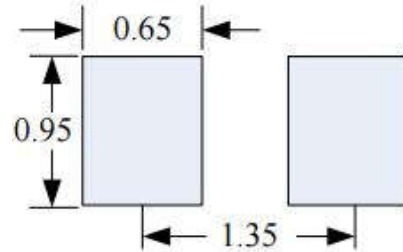

***Sizes in mm**

Notes:

This solder pad layout is for reference purposes only.

| Dimension | Unit: Millimeters | |
|-----------|-------------------|------|
| | Min. | Max. |
| L | 1.45 | 1.75 |
| W | 0.70 | 0.95 |
| P | 0.20 | 0.50 |
| H | 0.26 | 0.46 |

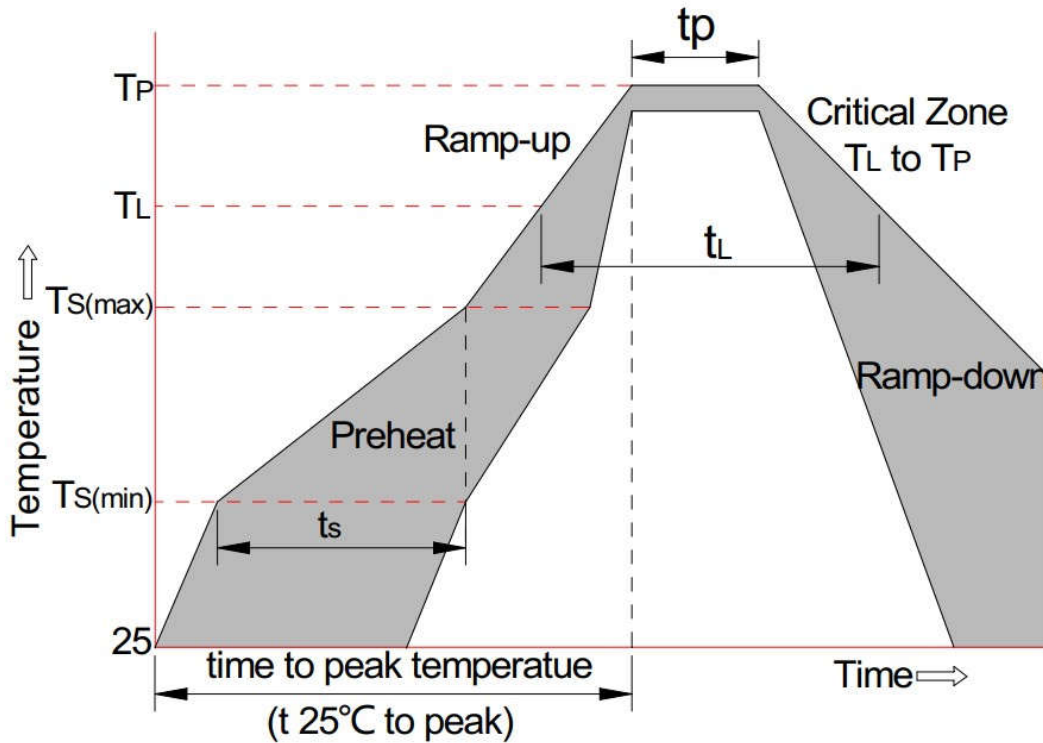

| Reflow Condition | | Pb-Free Assembly |
|--|-----------------------------|------------------|
| Pre-heat | -Temperature Min (Ts(min)) | +150°C |
| | -Temperature Max(Ts(max)) | +200°C |
| | -Time (Min to Max) (ts) | 60-180 secs. |
| Average ramp up rate (Liquid us Temp (TL) to peak) | | 3°C/sec. Max |
| Ts(max) to TL - Ramp-up Rate | | 3°C/sec. Max |
| Reflow | -Temperature(TL)(Liquid us) | +217°C |
| | -Temperature(tL) | 60-150 secs. |
| Peak Temp (Tp) | | +260(+0/-5)°C |
| Time within 5°C of actual Peak Temp (tp) | | 30 secs. Max |
| Ramp-down Rate | | 6°C/sec. Max |
| xTime 25°C to Peak Temp (TP) | | 8 min. Max |
| Do not exceed | | +260°C |

Disclaimer

The information presented in this document is for reference only. Guangdong Youfeng Microelectronics Co.,Ltd. reserves the right to make changes without notice for the specification of the products displayed herein to improve reliability, function or design or otherwise. The product listed herein is designed to be used with ordinary electronic equipment or devices, and not designed to be used with equipment or devices which require high level of reliability and the malfunction of which would directly endanger human life (such as medical instruments, transportation equipment, aerospace machinery, nuclear-reactor controllers, fuel controllers and other safety devices), YFW or anyone on its behalf, assumes no responsibility or liability for any damages resulting from such improper use of sale. This publication supersedes & replaces all information previously supplied. For additional information, please visit our website <https://www.yfwdiode.com>, or consult YFW sales office for further assistance.