

25A 3Quadrants TRIACs

Product Summary

Symbol	Value	Unit
$I_{T(AV)}$	25	A
$V_{DRM} V_{RRM}$	600/800	V
V_{TM}	1.55	V

Features

With high ability to withstand the shock loading of large current, With high commutation performances, 3 quadrants products especially recommended for use on inductive load.

Application

Washing machine, vacuums, massager, solid state relay, AC Motor speed regulation and so on.

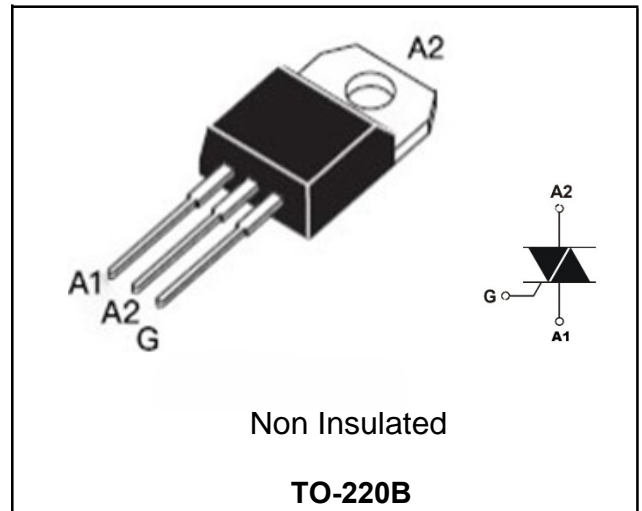

Absolute maximum ratings (Ta=25°C unless otherwise noted)

Parameter	Symbol	Value	Unit
Repetitive peak off-state voltage	V_{DRM}	600/800	V
Repetitive peak reverse voltage	V_{RRM}	600/800	V
RMS on-state current	$I_T(RMS)$	25	A
Non repetitive surge peak on-state current (full cycle, F=50Hz)	I_{TSM}	250	A
I^2t value for fusing (tp=10ms)	I^2t	340	A ² s
Critical rate of rise of on-state current ($I_G = 2 \times I_{GT}$)	di/dt	I - II - III 50	A/ μ s
Peak gate current	I_{GM}	4	A
Average gate power dissipation	$P_G (AV)$	1	W
Junction Temperature	T_J	-40 ~ +125	°C
Storage Temperature	T_{STG}	-40 ~ +150	°C

Electrical characteristics (TA=25°C, unless otherwise noted)

Parameter	Symbol	Test Condition	Value		Unit	
			CW	BW		
Gate trigger current	I_{GT}	$V_D=12V$ $R_L=33\Omega$ $T_J=25^\circ C$	I-II-III	≤ 35	≤ 50	mA
Gate trigger voltage	V_{GT}			I-II-III	≤ 1.3	
Gate non-trigger voltage	V_{GD}	$V_D = V_{DRM} T_J = 125^\circ C$		≥ 0.2		V
latching current	I_L	$I_G = 1.2 I_{GT}$	I-III	≤ 80	≤ 100	mA
			II	≤ 80	≤ 100	
Holding current	I_H	$I_T = 100mA$		≤ 50	≤ 75	mA
Critical-rate of rise of commutation voltage	dV_D/dt	$V_D = 2/3 V_{DRM}$ Gate Open $T_J = 125^\circ C$		≥ 500	≥ 1000	V/μs

STATIC CHARACTERISTICS

Forward "on" voltage	V_{TM}	$I_{TM} = 35A$ $t_p = 380\mu s$		≤ 1.55	V
Repetitive Peak Off-State Current	I_{DRM}	$V_D = V_{DRM}$ $V_R = V_{RRM}$	$T_J = 25^\circ C$	≤ 10	μA
Repetitive Peak Reverse Current	I_{RRM}		$T_J = 125^\circ C$	≤ 3	mA

THERMAL RESISTANCES

Thermal resistance	$R_{th(j-c)}$	Junction to case(AC)	1.1	$^\circ C/W$
	$R_{th(j-a)}$	Junction to ambient	45	$^\circ C/W$

Ordering Information

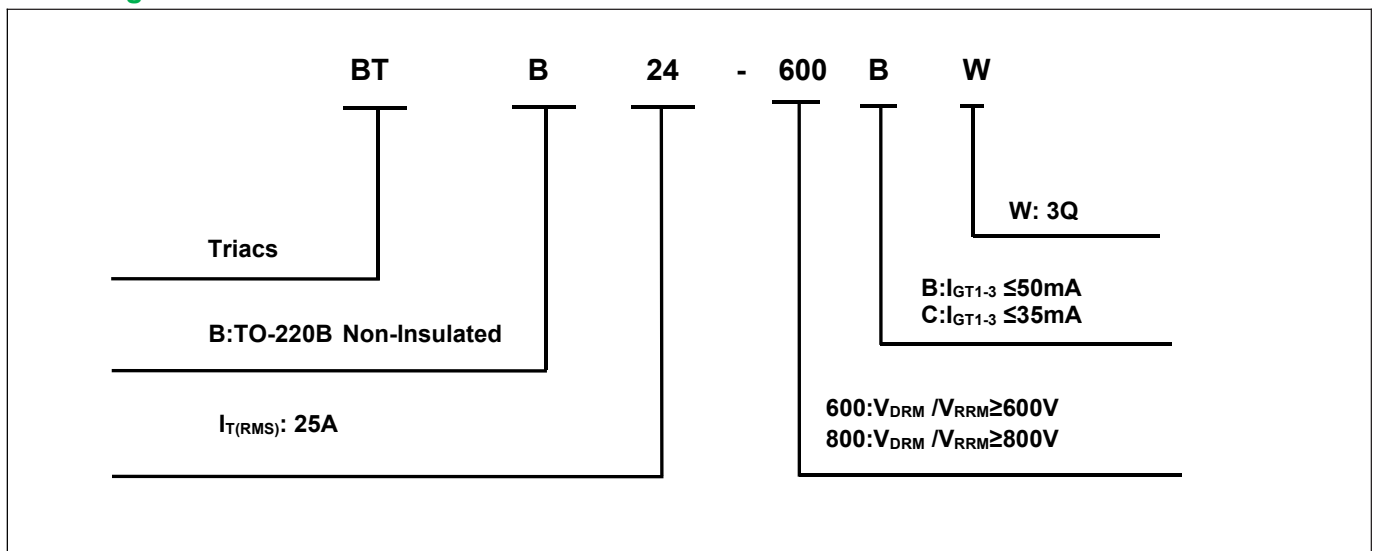

Typical Characteristics

FIG.1: Maximum power dissipation versus RMS on-state current (full cycle)

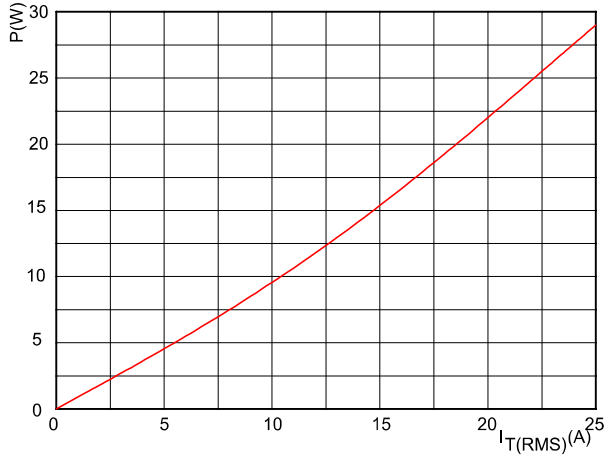

FIG.2: RMS on-state current versus case temperature (full cycle)

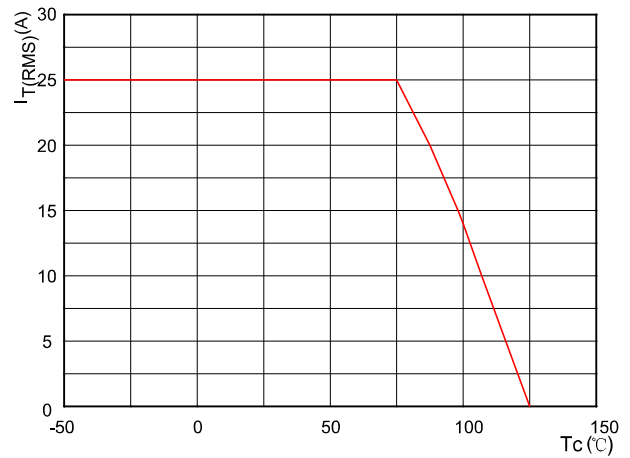

FIG.3: Surge peak on-state current versus number of cycles

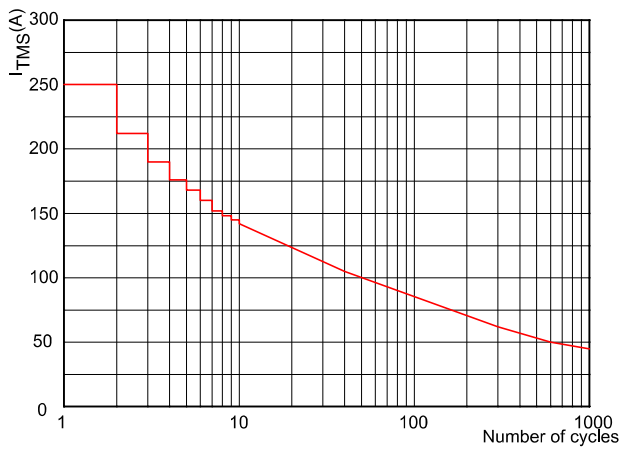

FIG.4: On-state characteristics (maximum values)

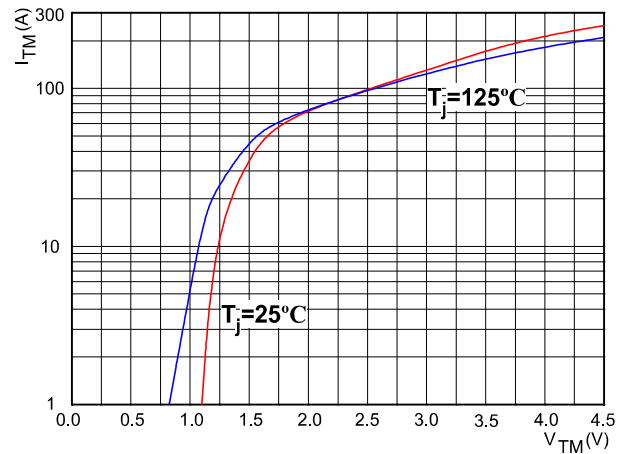

FIG.5: Non-repetitive surge peak on-state current for a sinusoidal pulse with width $t_p < 10\text{ms}$

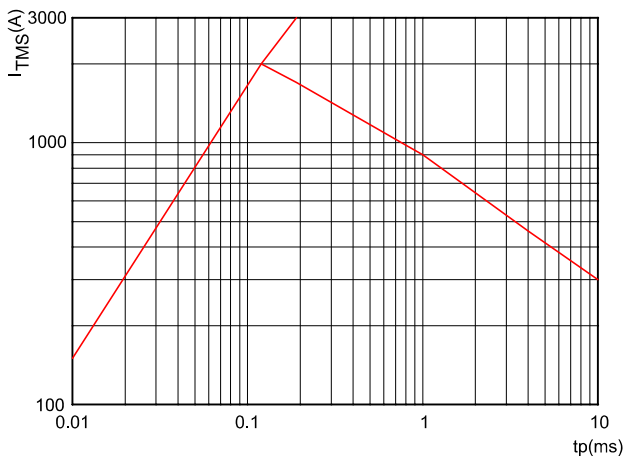
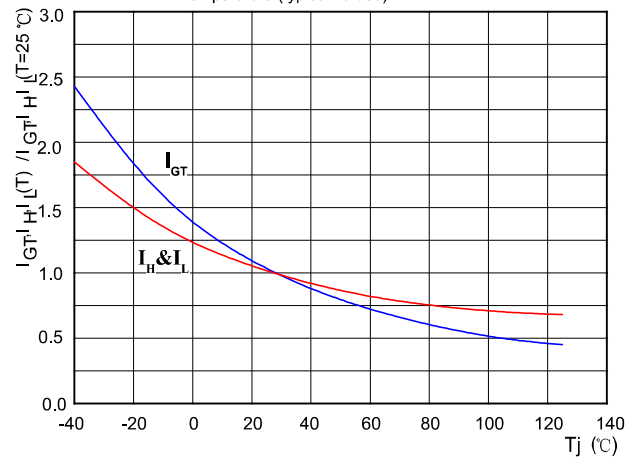
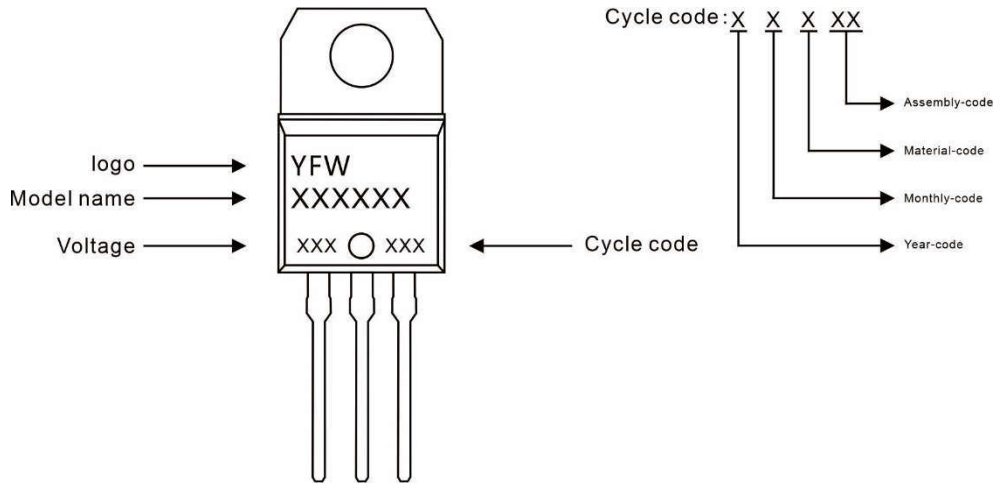

FIG.6: Relative variations of gate trigger current, holding current and latching current versus junction temperature (typical values)



Marking Diagram



Ordering information

Model name	Package	Unit Weight	Base Quantity	Packing Quantity
BTB24	TO-220B	0.07oz(1.96g)	50pcs/tube	1000PCS/Box 5000PCS/Carton

Package Dimensions
TO-220B(Non Insulated)

Symbol	Millimeter		Inches	
	Min.	Max.	Min.	Max.
A	9.80	10.40	0.386	0.409
B	2.65	3.10	0.104	0.122
C	14.80	16.10	0.583	0.634
D	0.70	0.92	0.028	0.036
D1	1.18	1.42	0.047	0.056
E	2.40	2.70	0.095	0.106
L	2.80	4.20	0.11	0.17
L1	13.05	13.60	0.514	0.535
H	5.85	6.82	0.23	0.27
K	2.35	2.75	0.093	0.108
T	4.38	4.61	0.172	0.181
T1	1.15	1.36	0.045	0.054
T2	0.35	0.65	0.014	0.026
ΦR	3.75	3.95	0.148	0.156

Disclaimer

The information presented in this document is for reference only. GuangDong Youfeng Microelectronics Co.,Ltd. reserves the right to make changes without notice for the specification of the products displayed herein to improve reliability, function or design or otherwise. The product listed herein is designed to be used with ordinary electronic equipment or devices, and not designed to be used with equipment or devices which require high level of reliability and the malfunction of which would directly endanger human life (such as medical instruments, transportation equipment, aerospace machinery, nuclear-reactor controllers, fuel controllers and other safety devices), YFW or anyone on its behalf, assumes no responsibility or liability for any damages resulting from such improper use of sale. This publication supersedes & replaces all information previously supplied. For additional information, please visit our website <https://www.yfwdiode.com>, or consult YFW sales office for further assistance.