

1200V N-Channel Enhancement Mode Power IGBT

MAIN CHARACTERISTICS

I_c @TC=100°C	40A
V_{CE}	1200V
VCE(sat)-typ	1.9V

FEATURES

- ◆ Trench and field-stop technology
- ◆ High speed switching
- ◆ Low collector to emitter saturation voltage
- ◆ Easy parallel switching capability
- ◆ High ruggedness performance
- ◆ RoHS compliant

APPLICATIONS

- ◆ Welding machines
- ◆ UPS
- ◆ Solar inverters

MECHANICAL DATA

- ◆ Case: Molded plastic
- ◆ Mounting Position: Any
- ◆ Molded Plastic: UL Flammability Classification Rating 94V-0
- ◆ Lead free in compliance with EU RoHS 2011/65/EU directive
- ◆ Solder bath temperature 275°C maximum, 10s per JESD 22-B106

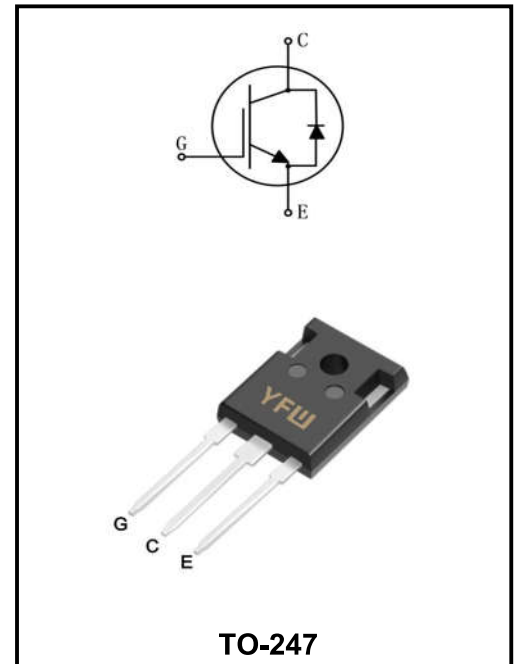

TO-247

Maximum Ratings

Characteristics	Symbol	Value	Unit
Collector-emitter voltage	V_{CES}	1200	V
Gate-emitter voltage	V_{GES}	±20	V
Continuous collector current (TC=25°C)	I_c	80	A
Continuous collector current (TC=100°C)		40	A
Pulsed collector current, tp limited by Tvjmax	I_{CM}	160	A
Diode continuous forward current (TC=100°C)	I_F	40	A
Diode maximum current, tp limited by Tvjmax	I_{FM}	160	A
Power dissipation (TC=25°C)	P_{tot}	681	W
Operating junction temperature range	T_{vj}	-40 to +175	°C
Storage temperature range	T_{stg}	-55 to +150	°C

Thermal characteristics

Characteristics	Symbol	Values		Unit
		Typ	Max.	
Thermal resistance, junction to case for IGBT	$R_{th(j-c)}$	-	0.22	K/ W
Thermal resistance, junction to case for Diode	$R_{th(j-c)}$	-	0.48	K/ W
Thermal resistance, junction to ambient	$R_{th(j-a)}$	-	40	K/ W

Note1:Pulse test: 300 μ s pulse width, 2 % duty cycle
Electrical characteristics of IGBT at $T_{vj}=25^{\circ}\text{C}$ unless otherwise specified

Characteristics	Test Condition	Symbol	Min	Typ	Max	Unit	
Collector-emitter breakdown voltage	$V_{GE}=0V, I_c=250\mu A$	$B_{V_{CES}}$	1200	-	-	V	
Collector-emitter leakage current	$V_{CE}=1200V, V_{GE}=0V$	I_{CES}	-	-	100	μA	
Gate leakage current, forward	$V_{GE}=\pm 20V, V_{CE}=0V$	I_{GES}	-	-	± 100	nA	
Gate-emitter threshold voltage	$V_{GE}=V_{CE}, I_c=1mA$	$V_{GE(th)}$	5	6	7	V	
Collector-emitter saturation voltage	$V_{GE}=15V, I_c=40A$	$V_{CE(sat)}$	-	1.9	-	V	
	$V_{GE}=15V, I_c=40A, T_{vj}=175^{\circ}\text{C}$		-	2.2	-	V	
Input capacitance	$V_{CE}=30V$ $V_{GE}=0V$ $f=1MHz$	C_{ies}	-	9900	-	pF	
Output capacitance		C_{oes}	-	189	-	pF	
Reverse transfer capacitance		C_{res}	-	40	-	pF	
Total gate charge	$V_{CC}=960V, V_{GE}=15V, I_c=40A$	Q_g	-	263	-	nC	
Turn-on delay time	$V_{CC}=600V$ $V_{GE}=0/15V$ $I_c=40A$ $R_G=10\Omega$ Inductive load	$t_d(on)$	-	85	-	ns	
Rise time		t_r	-	76	-	ns	
Turn-off delay time		$t_d(off)$	-	307	-	ns	
Fall time		t_f	-	69	-	ns	
Turn-on energy		E_{on}	-	2.5	-	mJ	
Turn-off energy		E_{off}	-	1.4	-	mJ	
Total switching energy		E_{ts}	-	3.9	-	mJ	
Turn-on delay time		$V_{CC}=600V$ $V_{GE}=0/15V$ $I_c=40A$ $R_G=10\Omega$ Inductive load $T_{vj}=175^{\circ}\text{C}$	$t_d(on)$	-	76	-	ns
Rise time			t_r	-	75	-	ns
Turn-off delay time			$t_d(off)$	-	360	-	ns
Fall time	t_f		-	149	-	ns	
Turn-on energy	E_{on}		-	2.9	-	mJ	
Turn-off energy	E_{off}		-	2.6	-	mJ	
Total switching energy	E_{ts}		-	5.5	-	mJ	
Diode forward voltage	$I_F=40A$		V_F	-	2	-	V
	$I_F=40A, T_{vj}=175^{\circ}\text{C}$	-		1.6	-	V	
Diode reverse recovery time	$V_R=600V$ $I_F=40A$	t_{rr}	-	175	-	ns	
Diode peak reverse recovery current	$di_F/dt=-750A/\mu s$	I_{rrm}	-	24	-	A	
Diode reverse recovery charge		Q_{rr}	-	2000	-	nC	
Diode reverse recovery time	$V_R=600V$ $I_F=40A$	t_{rr}	-	285	-	ns	
Diode peak reverse recovery current	$di_F/dt=-750A/\mu s, T_{vj}=175^{\circ}\text{C}$	I_{rrm}	-	37	-	A	
Diode reverse recovery charge		Q_{rr}	-	5500	-	nC	

RATINGS AND CHARACTERISTIC CURVES

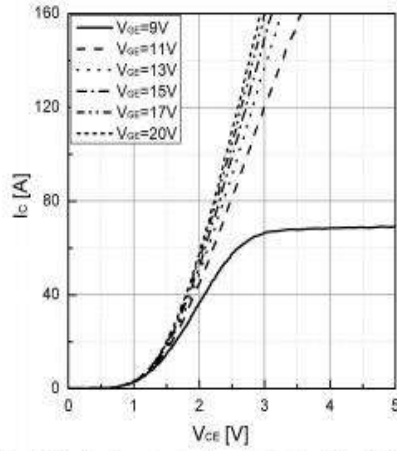

Fig 1. Typical output characteristic ($T_{vj}=25^{\circ}\text{C}$)

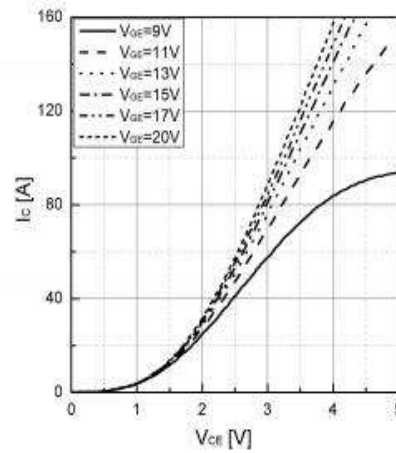

Fig 2. Typical output characteristic ($T_{vj}=175^{\circ}\text{C}$)

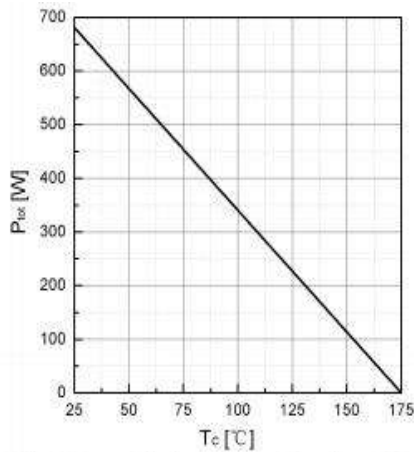

Fig 3. Power dissipation as a function of T_c

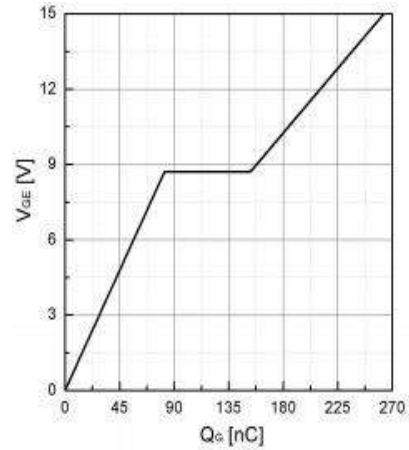

Fig 4. Typical Gate charge

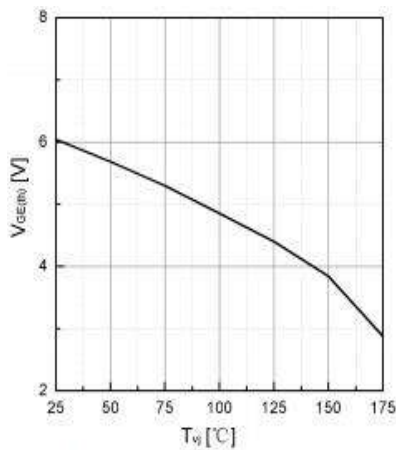

Fig 5. Typical $V_{GE(th)}$ as a function of T_{vj}
($I_C=1\text{mA}$)

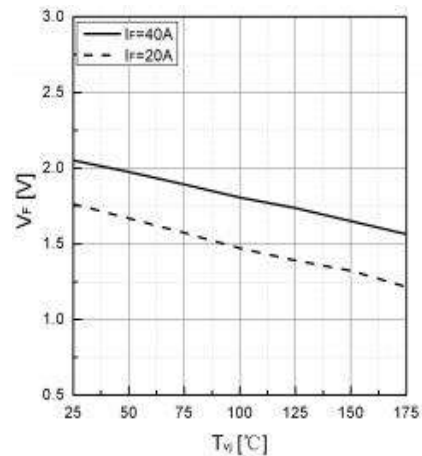

Fig 6. Typical V_F as a function of T_{vj}

RATINGS AND CHARACTERISTIC CURVES

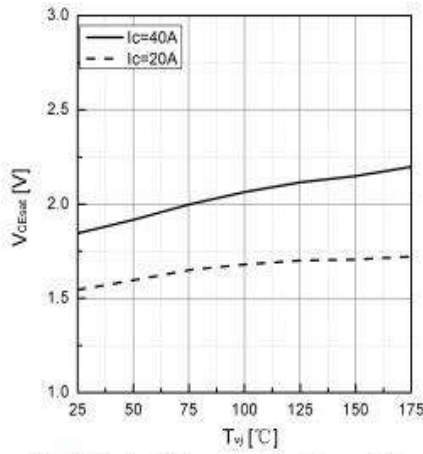

Fig 7. Typical V_{CEsat} as a function of T_{vj}

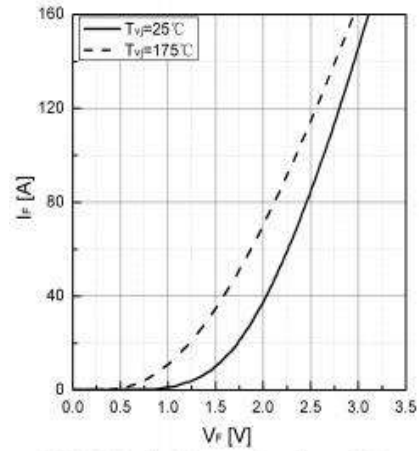

Fig 8. Typical I_F as a function of V_F

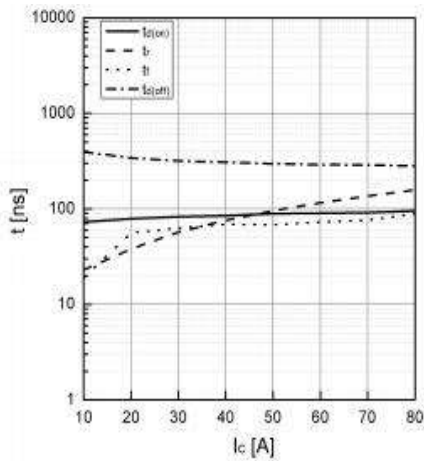

Fig 9. Typical switching time as a function of I_c

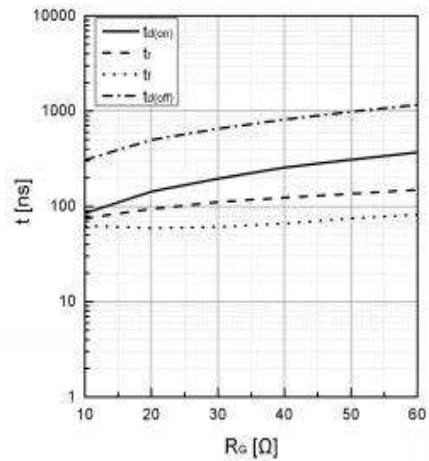

Fig 10. Typical switching times as a function of R_G

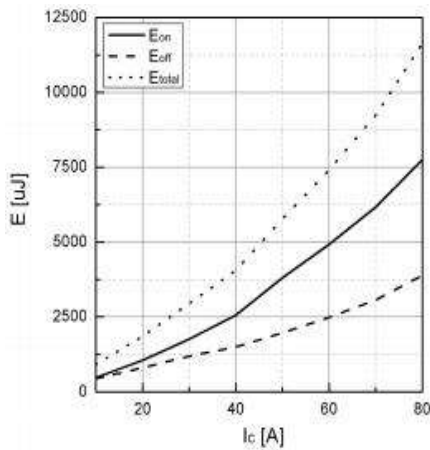

Fig 11. Typical switching energy losses as a function of I_c

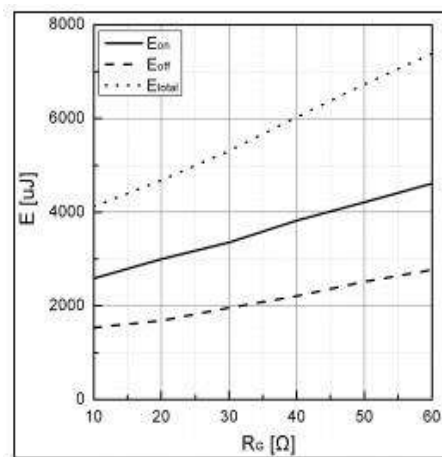

Fig 12. Typical switching energy losses as a function of R_G

RATINGS AND CHARACTERISTIC CURVES

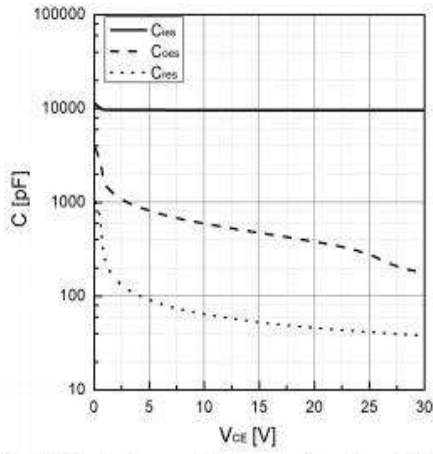

Fig 13. Typical capacitance as a function of V_{CE}
(f=1Mhz, V_{GE}=0V)

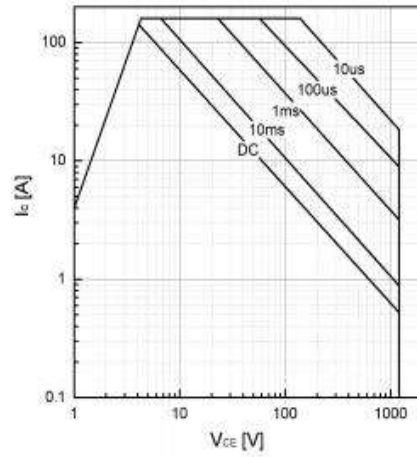

Fig 14. Safe operating area

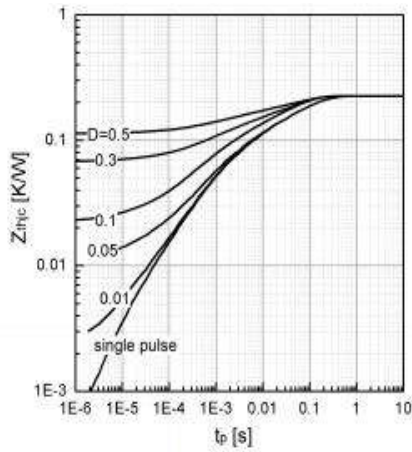
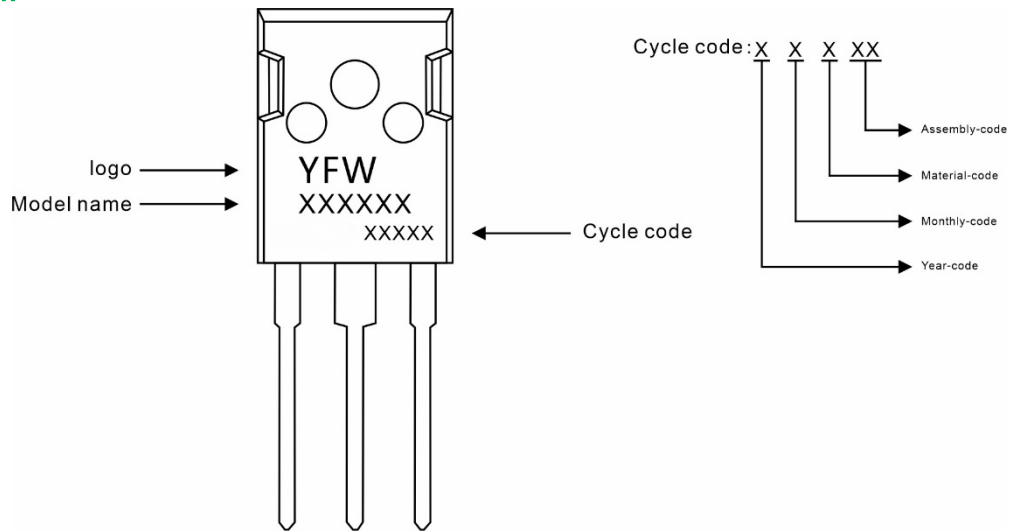

Fig 15. Transient thermal impedance of IGBT

Marking Diagram



Ordering information

Model name	Package	Unit Weight	Base Quantity	Packing Quantity
YFWG40T120HAP	TO-247	0.209oz(5.93g)	30pcs/tube	600PCS/Box 2400PCS/Carton

Package Dimensions

TO-247

Symbol	Dimensions in mm		Dimensions in Inch	
	Min.	Max.	Min.	Max.
A	4.90	5.10	0.193	0.201
A1	1.90	2.10	0.075	0.083
A2	2.29	2.54	0.090	0.100
b	1.00	1.40	0.039	0.055
b1	2.00	2.20	0.079	0.087
b2	3.00	3.20	0.118	0.126
c	0.50	0.70	0.020	0.028
D	15.75	16.05	0.620	0.632
E	20.20	20.80	0.795	0.819
e	5.45 (BSC)		0.215 (BSC)	
e1	10.90 (BSC)		0.429 (BSC)	
F	6.05	6.25	0.238	0.246
F1	5.80	6.00	0.228	0.236
L	20.10	20.40	0.791	0.803
L1	4.05	4.35	0.159	0.171
Φ	3.50	3.70	0.138	0.146

Disclaimer

The information presented in this document is for reference only. Guangdong Youfeng Microelectronics Co.,Ltd. reserves the right to make changes without notice for the specification of the products displayed herein to improve reliability, function or design or otherwise. The product listed herein is designed to be used with ordinary electronic equipment or devices, and not designed to be used with equipment or devices which require high level of reliability and the malfunction of which would directly endanger human life (such as medical instruments, transportation equipment, aerospace machinery, nuclear-reactor controllers, fuel controllers and other safety devices), YFW or anyone on its behalf, assumes no responsibility or liability for any damages resulting from such improper use of sale. This publication supersedes & replaces all information previously supplied. For additional information, please visit our website <https://www.yfwdiode.com>, or consult YFW sales office for further assistance.