

4.0A GLASS PASSIVATED BRIDGE RECTIFIER
Reverse Voltage – 50 to 1000 V
Forward Current – 4.0A
Features

- ◆The plastic package carries Underwriters Laboratory Flammability Classification 94V-0
- ◆Idea for printed circuit board
- ◆Glass passivated junction chip
- ◆Low reverse leakage
- ◆High forward surge current capability
- ◆High temperature soldering guaranteed 260°C/10 seconds at terminals

Mechanical Data

- ◆Case:Molded plastic body
- ◆Terminals :Solder plated, solderable per MIL-STD-750,Method 2026
- ◆Polarity :Polarity symbol marking on body
- ◆Mounting Position:Any
- ◆Weight : 0.0078 ounce, 0.22 grams

Maximum Ratings and Electrical characteristics

Ratings at 25 °C ambient temperature unless otherwise specified. Single phase half-wave 60 Hz, resistive or inductive load, for capacitive load current derate by 20 %.

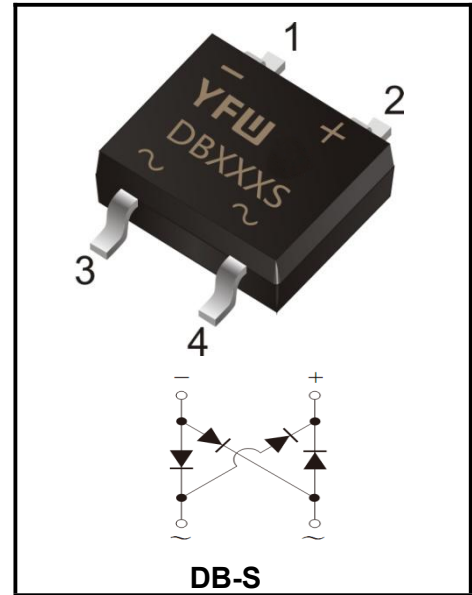

Parameter	Symbols	DB401S	DB402S	DB403S	DB404S	DB405S	DB406S	DB407S	Units
Maximum Repetitive Peak Reverse Voltage	V_{RRM}	50	100	200	400	600	800	1000	V
Maximum RMS voltage	V_{RMS}	35	70	140	280	420	560	700	V
Maximum DC Blocking Voltage	V_{DC}	50	100	200	400	600	800	1000	V
Maximum average forward rectified current at $T_L=100^{\circ}C$	$I_{(AV)}$	4.0							A
Peak forward surge current, 8.3ms single half sine-wave superimposed on rated load	I_{FSM}	90							A
Rating for fusing ($t=8.3ms, T_a=25^{\circ}C$)	I^2t	33.6							A ² s
Maximum instantaneous forward voltage at 4.0A	V_F	1.1							V
Maximum DC Reverse Current @ $T_A=25^{\circ}C$ at Rated DC Blocking Voltage @ $T_A=125^{\circ}C$	I_R	2.0 200							μA
Typical Junction Capacitance (Note1)	C_j	38							pF
Typical Thermal Resistance	$R_{\theta JA}$	68							$^{\circ}C/W$
Operating and Storage Temperature Range	T_j, T_{stg}	-55 ~ +150							$^{\circ}C$

Note: 1. Measured at 1MHz and applied reverse voltage of 4.0V D.C.

Ratings And Characteristic Curves

FIG. 1- DERATING CURVE OUTPUT RECTIFIED CURRENT

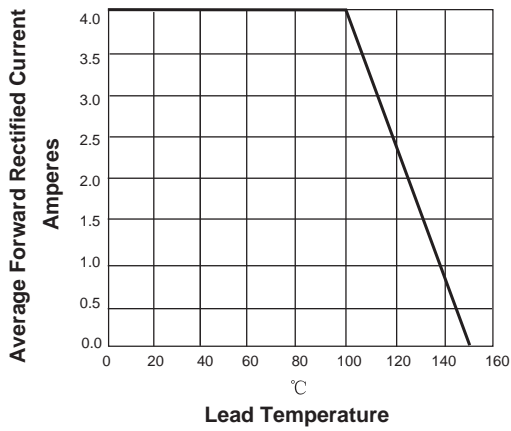

FIG. 2-MAXIMUM NON-REPETITIVE PEAK FORWARD SURGE CURRENT PER LEG

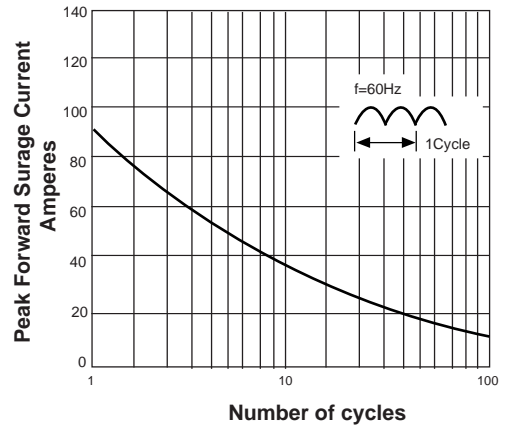

FIG. 3-TYPICAL FORWARD VOLTAGE CHARACTERISTICS

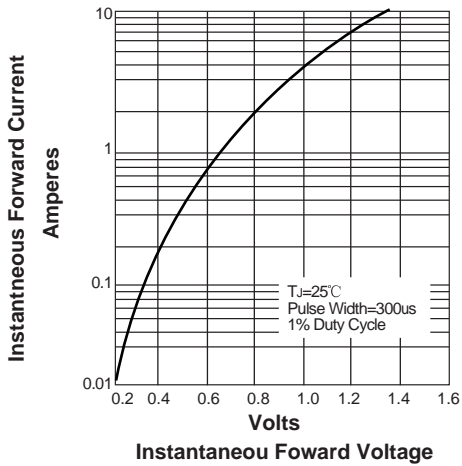
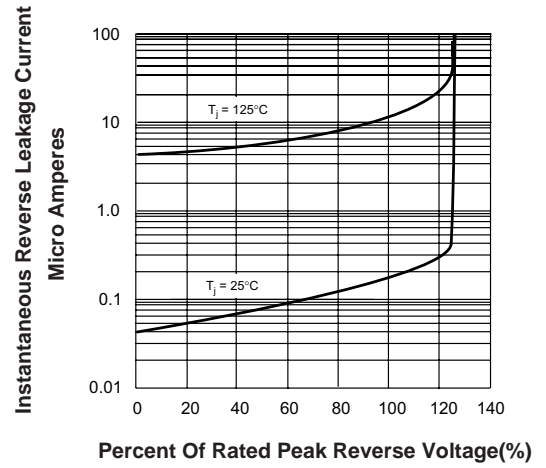
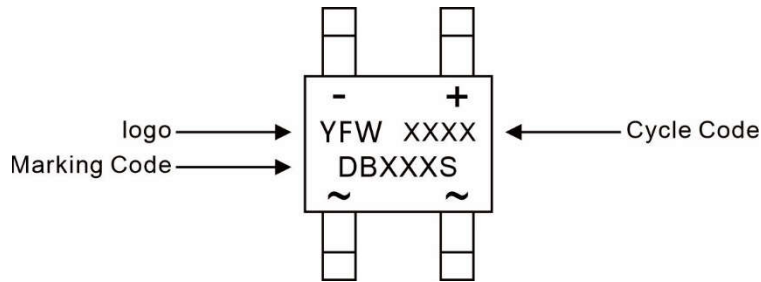

FIG. 4-TYPICAL REVERSE LEAKAGE CHARACTERISTICS



Marking Diagram



Ordering information

Package	Packing Description	Packing Quantity
DB-S	Tape/Reel, 13" reel	1500PCS/Reel 27000PCS/Carton

Package Dimensions

DB-S

Dim.	Millimeter(mm)		Dimensions in Inch	
	Min.	Max.	Min.	Max.
A	6.00	6.60	0.24	0.26
B	9.80	10.20	0.39	0.40
C	4.80	5.40	0.19	0.21
D	8.13	8.51	0.320	0.335
E	2.80	3.30	0.110	0.130
F	1.02	1.20	0.040	0.047
G	0.22	0.33	0.009	0.013
H	1.02	1.53	0.040	0.060
I	1.80	2.10	0.070	0.083

The recommended mounting pad size

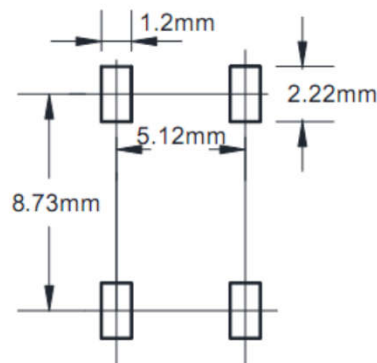

Disclaimer

The information presented in this document is for reference only. GuangDong Youfeng Microelectronics Co.,Ltd. reserves the right to make changes without notice for the specification of the products displayed herein to improve reliability, function or design or otherwise. The product listed herein is designed to be used with ordinary electronic equipment or devices, and not designed to be used with equipment or devices which require high level of reliability and the malfunction of which would directly endanger human life (such as medical instruments, transportation equipment, aerospace machinery, nuclear-reactor controllers, fuel controllers and other safety devices), YFW or anyone on its behalf, assumes no responsibility or liability for any damages resulting from such improper use of sale. This publication supersedes & replaces all information previously supplied. For additional information, please visit our website <https://www.yfwdiode.com>, or consult YFW sales office for further assistance.