

## Glass Passivated Single-Phase 6.0Amp Fast Recovery Surface Mount Bridge Rectifier

Reverse Voltage - 200 to 1000 V

Forward Current - 6.0 A

### FEATURES

- ◆ Surface mount bridge, small package;
- ◆ Ideal for printed circuit boards;
- ◆ Glass passivated chip junction;
- ◆ High forward current capability up to 6.0A;
- ◆ High surge current capability;
- ◆ Fast recovery, low switching loss;
- ◆ Low profile package;
- ◆ Low forward voltage drop, low power losses;
- ◆ Plastic package has Underwrites Laboratory Flammability Classification 94V-0;

### MECHANICAL DATA

- ◆ Case: HBS;
- ◆ Epoxy meets UL-94V-0 Flammability rating;
- ◆ Terminals: Matte tin plated leads, solderable per J-STD-002 and JESD22-B102;
- ◆ High temperature soldering guaranteed:  
Solder Reflow 260°C, 10seconds;
- ◆ Polarity: As marked on body;
- ◆ Marking: Type number;

### Typical Applications

- ◆ General purpose use in AC-to-DC bridge full wave rectification for Fast Charging, Switching Power Supply, USB PD, Adapter and 3-in-1 Power Board, etc.

### Maximum Ratings And Electrical Characteristics

Ratings at 25°C ambient temperature unless otherwise specified.

Single Phase, half wave, 60Hz, resistive or inductive load. For capacitive load, derate current by 20%.

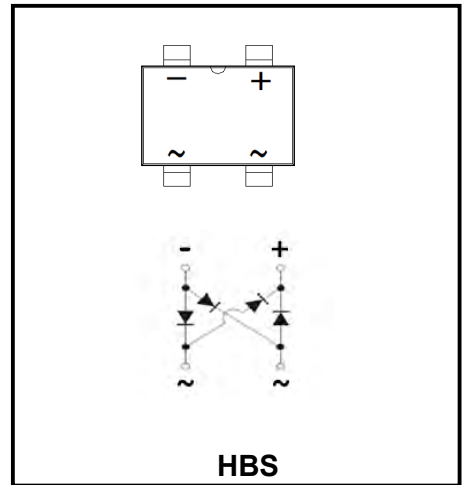

Parameter	Symbols	RHBS602	RHBS604	RHBS606	RHBS608	RHBS610	Units
Maximum Repetitive Peak Reverse Voltage	$V_{RRM}$	200	400	600	800	1000	V
Maximum RMS Voltage	$V_{RMS}$	140	280	420	560	700	V
Maximum DC Blocking Voltage	$V_{DC}$	200	400	600	800	1000	V
Maximum average forward rectified output current at $T_A=25^\circ C$	$I_{F(AV)}$	6.0					A
Peak Forward Surge Current, 8.3ms Single Half Sine-Wave, Superimposed on Rated Load (JEDEC Method)	$I_{FSM}$	170					A
$I^2t$ Rating for Fusing ( $t < 8.3ms$ )	$I^2t$	120					A <sup>2</sup> S
Instantaneous forward voltage drop per diode @ $I_F=1.0A$ @ $I_F=3.0A$ @ $I_F=6.0A$	$V_F$	0.86 Typ. 0.91 max. 0.95 Typ. 1.0 max. 1.02 Typ. 1.07 max.					V
Reverse Current at Rated DC Blocking Voltage $T_A=25^\circ C$ $T_A=125^\circ C$	$I_R$	0.16 Typ. 5.0 max. 43.0 Typ. 100 max.					$\mu A$
Maximum reverse recovery time ( $I_F=0.5A, I_R=1.0A, I_{rr}=0.25A$ )	$T_{rr}$	150		250		500	ns
Typical capacitance (note1)	$C_j$	41					pF
Typical thermal resistance	$R_{\theta J-A}$ $R_{\theta J-C}$ $R_{\theta J-L}$	72.0 14.0 12.0					$^\circ C/W$
Operating and Storage Temperature Range	$T_j, T_{stg}$	-55 to +150					$^\circ C$

Note1: Measured at 1.0MHz and applied reverse voltage of 5.0V DC;

**Ratings and Characteristics Curves**

(TA = 25°C unless otherwise noted)

**FIG.1 Derating Curve Output Rectified Current**

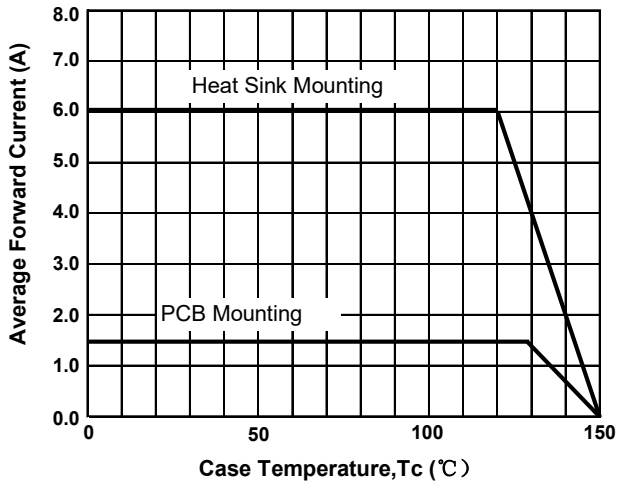

**FIG.2 Typical Forward Characteristics per Diode**

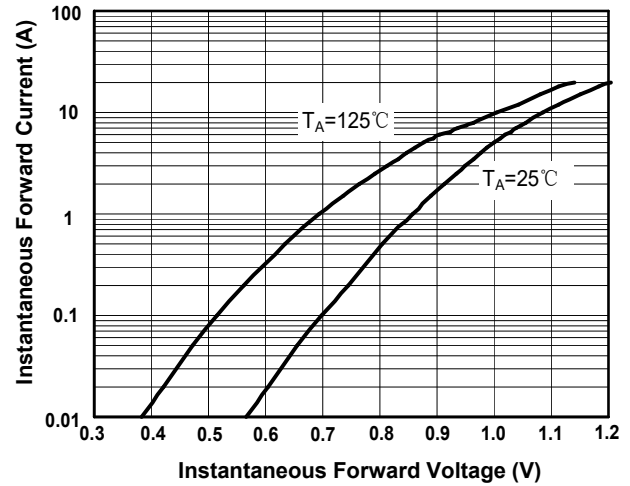

**FIG.3 Maximum Non-Repetitive Peak Forward Surge Current per Diode**

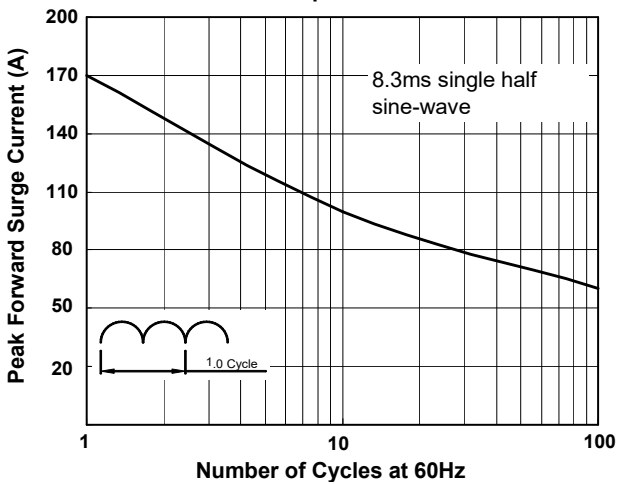

**FIG.4 Typical Reverse Characteristics per Diode**

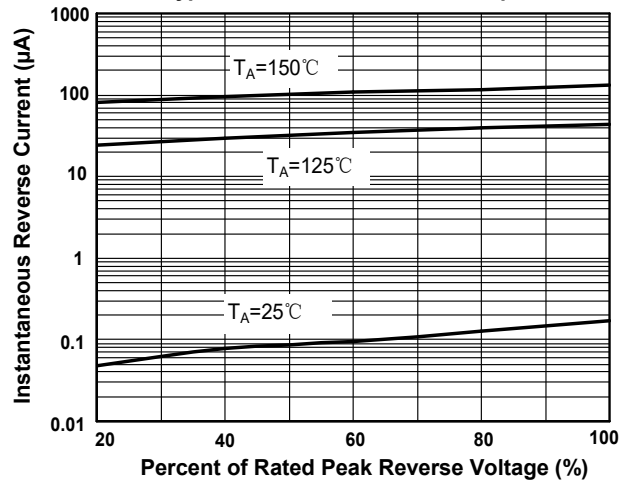

**FIG.5 Typical Junction Capacitance per Diode**

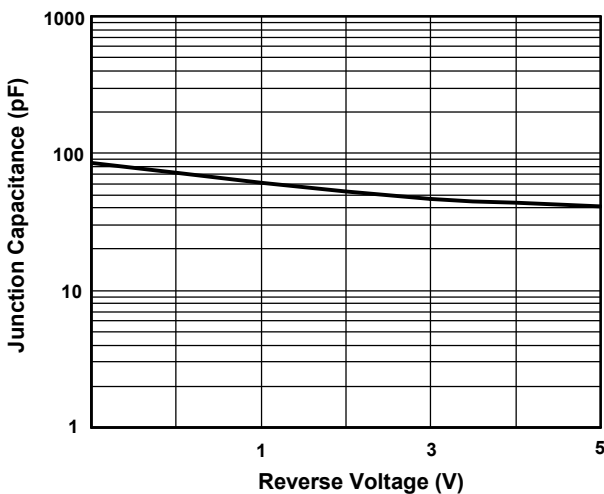

**Marking Diagram**

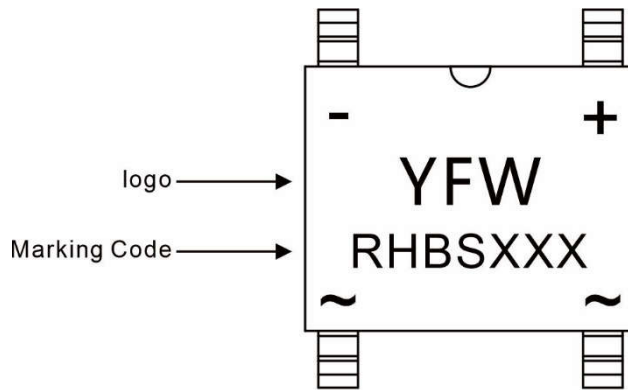

**Ordering information**

Package	Packing Description	Packing Quantity
HBS	Tape/Reel, 13" reel	2500PCS/Reel 25000PCS/Carton

**Package Dimensions**

**HBS**

Dim	Millimeter(mm)		Dimensions inInch	
	Min.	Max.	Min.	Max.
A	10.0	10.4	0.39	0.41
B	7.0	7.4	0.28	0.29
C	1.4	1.7	0.06	0.07
D	9.7	10.2	0.38	0.40
E	5.3	5.7	0.21	0.22
F	1.7	2.0	0.07	0.08

**The recommended mounting pad size Unit: inches (mm)**

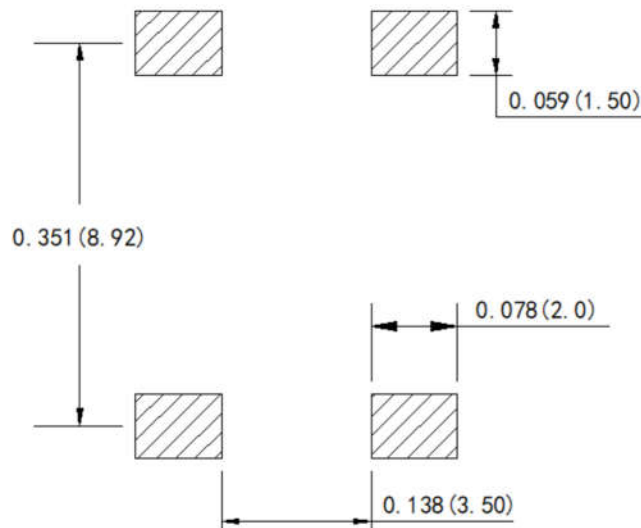

## Disclaimer

The information presented in this document is for reference only. Guangdong Youfeng Microelectronics Co.,Ltd. reserves the right to make changes without notice for the specification of the products displayed herein to improve reliability, function or design or otherwise. The product listed herein is designed to be used with ordinary electronic equipment or devices, and not designed to be used with equipment or devices which require high level of reliability and the malfunction of which would directly endanger human life (such as medical instruments, transportation equipment, aerospace machinery, nuclear-reactor controllers, fuel controllers and other safety devices), YFW or anyone on its behalf, assumes no responsibility or liability for any damages resulting from such improper use of sale. This publication supersedes & replaces all information previously supplied. For additional information, please visit our website <https://www.yfwdiode.com>, or consult YFW sales office for further assistance.