

1A SURFACE MOUNT GLASS PASSIVATED BRIDGE

RECTIFIER Reverse Voltage - 100 to 1000 V

Forward Current - 1A

FEATURES

- ◆High current capability
- ◆Low forward voltage drop
- ◆Glass Passivated Chip Junction
- ◆Low power loss, high efficiency
- ◆Lead free in comply with EU RoHS 2011/65/EU directives

MECHANICAL DATA

- ◆Case: MBS
- ◆Terminals: Solderable per MIL-STD-750, Method 2026
- ◆Approx. Weight: 100mg / 0.0035oz

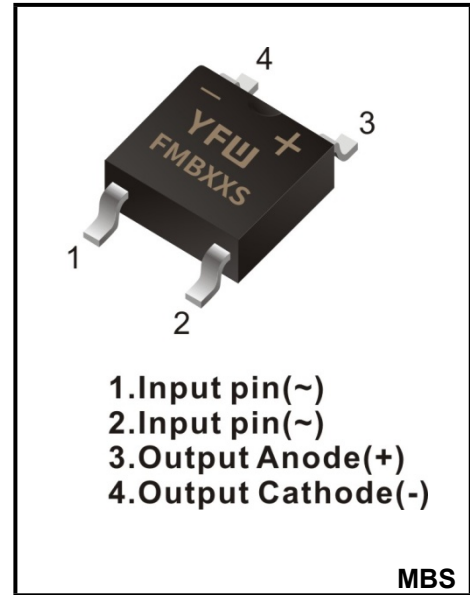

Maximum Ratings and Electrical characteristics

Ratings at 25 °C ambient temperature unless otherwise specified.

Single phase half-wave 60 Hz, resistive or inductive load, for capacitive load current derate by 20 %.

Parameter	Symbols	FMB1S	FMB2S	FMB4S	FMB6S	FMB8S	FMB10S	Units
Maximum Repetitive Peak Reverse Voltage	V_{RRM}	100	200	400	600	800	1000	V
Maximum RMS voltage	V_{RMS}	70	140	280	420	560	700	V
Maximum DC Blocking Voltage	V_{DC}	100	200	400	600	800	1000	V
Average Rectified Output Current at $T_c = 125\text{ }^\circ\text{C}$	I_o	1						A
Peak Forward Surge Current 8.3 ms Single Half Sine-Wave Superimposed on Rated Load (JEDEC method)	I_{FSM}	35						A
Forward Voltage per element at 1.0A	V_F $V_F(\text{typ})$	1.1 1.0						V
Maximum DC Reverse Current @ $T_A=25\text{ }^\circ\text{C}$ at Rated DC Blocking Voltage @ $T_A=125\text{ }^\circ\text{C}$	I_R	5 50						μA
Typical Junction Capacitance (Note1)	C_j	15						pF
Maximum Reverse Recovery Time (Note2)	T_{rr} $T_{rr}(\text{typ})$	500 300						nS
Typical Thermal Resistance (Note3)	$R_{\theta JA}$ $R_{\theta JC}$	80 30						$^\circ\text{C/W}$
Operating and Storage Temperature Range	T_j, T_{stg}	-55 ~ +150						$^\circ\text{C}$

(1) Measured at 1 MHz and applied reverse voltage of 4 V D.C

(2) Mounted on glass epoxy PC board with 4×1.5"×1.5" (3.81×3.81 cm) copper pad.

Fig.1 Average Rectified Output Current Derating Curve

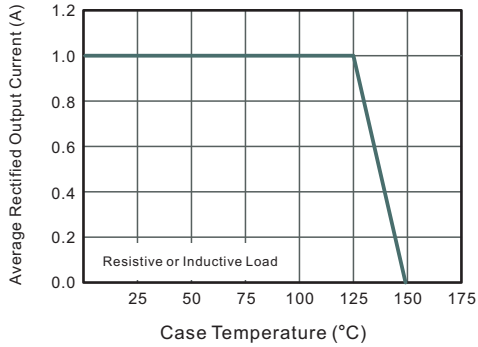

Fig.2 Typical Reverse Characteristics

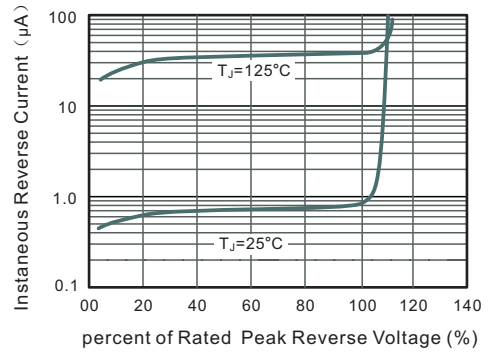

Fig.3 Typical Instantaneous Forward Characteristics

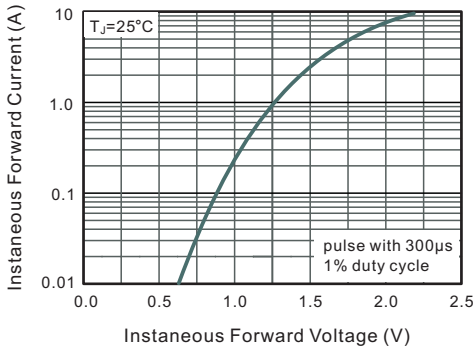

Fig.4 Typical Junction Capacitance

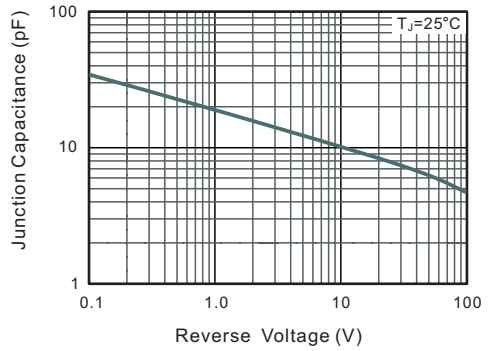
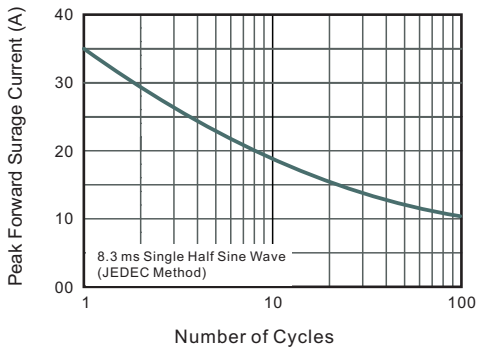
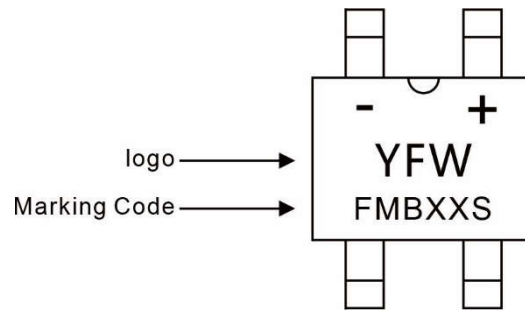

Fig.5 Maximum Non-Repetitive Peak Forward Surge Current



Marking Diagram



Ordering information

Package	Packing Description	Packing Quantity
MBS	Tape/Reel, 13" reel	3000PCS/Reel 30000PCS/Carton

Package Dimensions

MBS

Dim.	Millimeter(mm)		(mil)	
	Min.	Max.	Min.	Max.
A	2.2	2.6	94	102
C	0.15	0.22	5.9	8.7
D	4.5	5.0	177	197
E	3.6	4.1	142	161
HE	6.4	7.0	252	276
d	2.3	2.7	91	106
e	0.5	0.7	20	28
L	1.3	1.7	51	67
L1	0.5	1.1	20	43
a	/	0.2	/	8
∠	7°			

The recommended mounting pad size

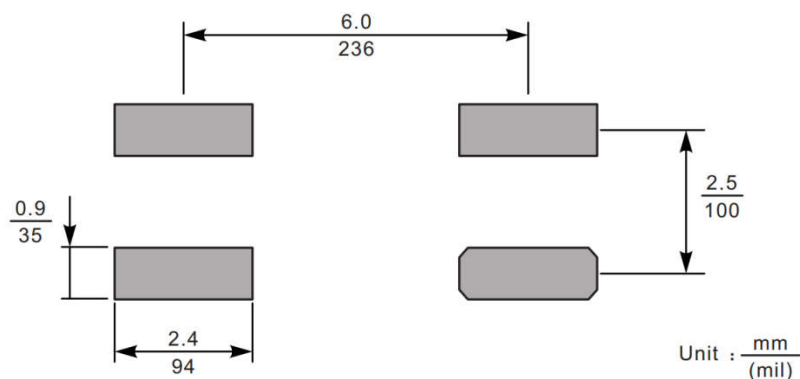

Disclaimer

The information presented in this document is for reference only. Guangdong Youfeng Microelectronics Co.,Ltd. reserves the right to make changes without notice for the specification of the products displayed herein to improve reliability, function or design or otherwise. The product listed herein is designed to be used with ordinary electronic equipment or devices, and not designed to be used with equipment or devices which require high level of reliability and the malfunction of which would directly endanger human life (such as medical instruments, transportation equipment, aerospace machinery, nuclear-reactor controllers, fuel controllers and other safety devices), YFW or anyone on its behalf, assumes no responsibility or liability for any damages resulting from such improper use of sale. This publication supersedes & replaces all information previously supplied. For additional information, please visit our website <https://www.yfwdiode.com>, or consult YFW sales office for further assistance.