

## 4.0A SURFACE MOUNT GLASS PASSIVATED BRIDGE

RECTIFIER Reverse Voltage - 100 to 1000 V

Forward Current – 4.0A

### FEATURES

- ◆Fast reverse recovery time
- ◆Designed for Surface Mount Application
- ◆Glass Passivated Chip Junction
- ◆Low power loss, high efficiency
- ◆Lead free in comply with EU RoHS 2011/65/EU directives

### MECHANICAL DATA

- ◆Case: UMSB
- ◆Terminals: Solderable per MIL-STD-750, Method 2026
- ◆Approx. Weight: 0.234g / 0.00824oz

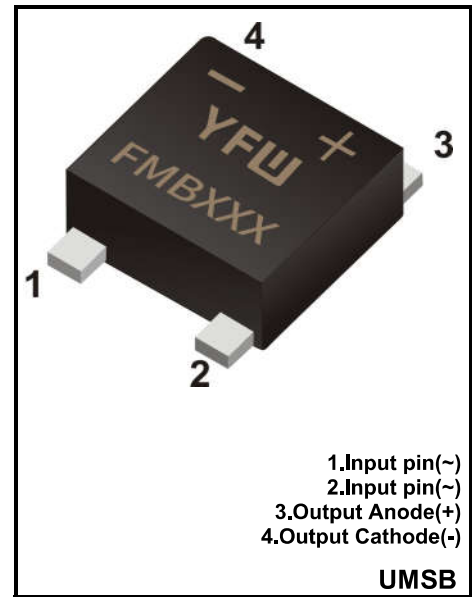

### Maximum Ratings and Electrical characteristics

Ratings at 25 °C ambient temperature unless otherwise specified.

Single phase half-wave 60 Hz, resistive or inductive load, for capacitive load current derate by 20 %.

Parameter	Symbols	FMSB40B	FMSB40D	FMSB40G	FMSB40J	FMSB40K	FMSB40M	Units
Maximum Repetitive Peak Reverse Voltage	$V_{RRM}$	100	200	400	600	800	1000	V
Maximum RMS voltage	$V_{RMS}$	70	140	280	420	560	700	V
Maximum DC Blocking Voltage	$V_{DC}$	100	200	400	600	800	1000	V
Average Rectified Output Current at $T_c = 115\text{ }^\circ\text{C}$	$I_o$	4.0						A
Peak Forward Surge Current 8.3 ms Single Half Sine-Wave Superimposed on Rated Load(JEDEC method)	$I_{FSM}$	95						A
Forward Voltage per element at 4.0A	$V_F$	1.1						V
Maximum DC Reverse Current @ $T_A=25\text{ }^\circ\text{C}$ at Rated DC Blocking Voltage @ $T_A=125\text{ }^\circ\text{C}$	$I_R$	5.0 200						$\mu\text{A}$
Typical Junction Capacitance <sup>(Note1)</sup>	$C_j$	50						pF
Maximum Reverse Recovery Time <sup>(Note2)</sup>	$T_{rr}$	150			250	500		nS
Typical Thermal Resistance <sup>(Note3)</sup>	$R_{\theta JA}$ $R_{\theta JC}$ $R_{\theta JL}$	60 15 25						$^\circ\text{C/W}$
Operating and Storage Temperature Range	$T_j, T_{stg}$	-55 ~ +150						$^\circ\text{C}$

(1) Measured at 1 MHz and applied reverse voltage of 4 V D.C

(2) Mounted on glass epoxy PC board with 4×1.5"×1.5" (3.81×3.81 cm) copper pad.

**Fig.1 Average Rectified Output Current Derating Curve**

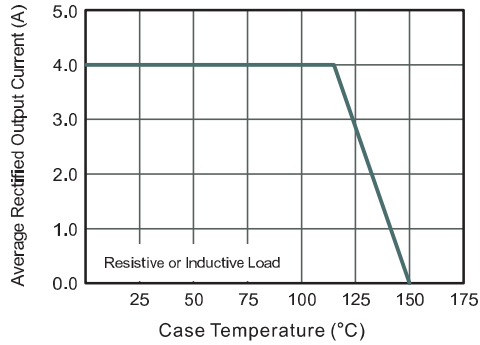

**Fig.2 Typical Reverse Characteristics**

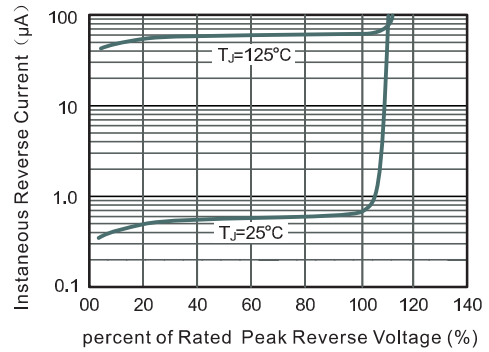

**Fig.3 Typical Instantaneous Forward Characteristics**

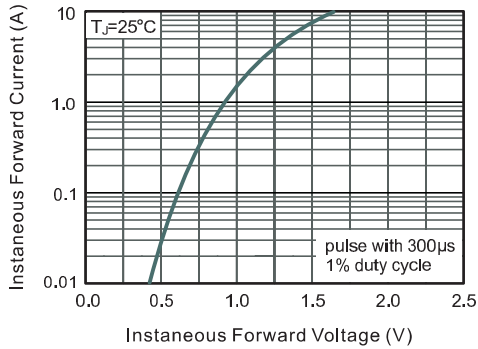

**Fig.4 Typical Junction Capacitance**

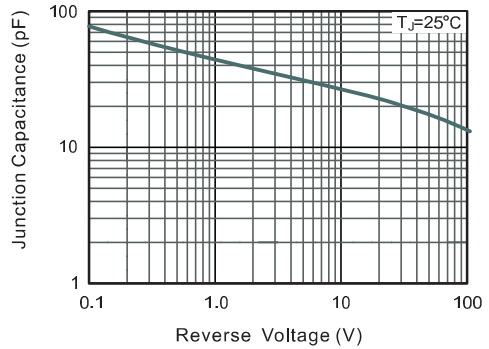

**Fig.5 Maximum Non-Repetitive Peak Forward Surge Current**

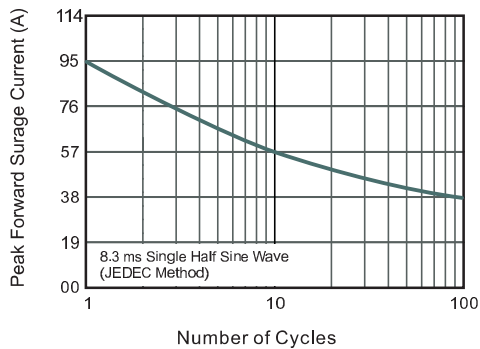

**Fig.6- Typical Transient Thermal Impedance**

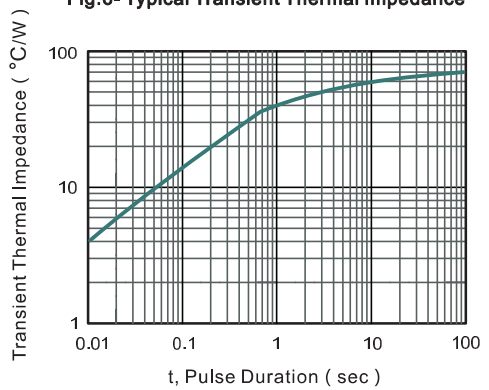

Marking Diagram

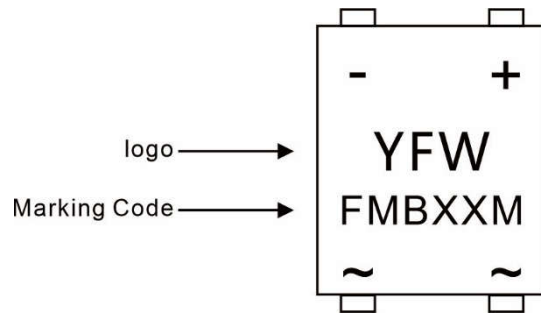

Ordering information

Package	Packing Description	Packing Quantity
UMSB	Tape/Reel, 13" reel	3000PCS/Reel 30000PCS/Carton

Package Dimensions

UMSB

Dim.	Millimeter(mm)		(mil)	
	Min.	Max.	Min.	Max.
A	1.3	1.5	51	59
C	0.17	0.29	7	12
D	6.2	7.0	244	276
E	7.1	7.6	280	299
E <sub>1</sub>	8.4	8.9	331	350
L	1.0	1.6	31.5	55
e	4.9	5.3	193	209
b	0.95	1.15	37	45
∠	10°			

The drawings show the package from top, side, and lead profile views. Dimensions are labeled as follows: E (width), D (height), b (lead width), L (lead length), e (pitch), A (lead height), E<sub>1</sub> (lead length), and G (lead thickness). A note indicates 'ALL ROUND' for the lead profile.

The recommended mounting pad size

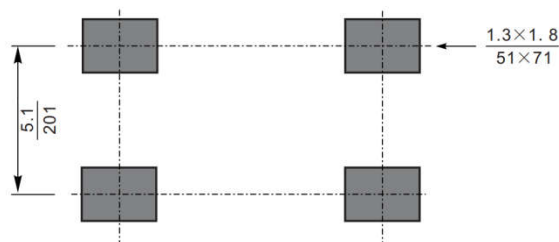

Unit:  $\frac{\text{mm}}{\text{(mil)}}$

## Disclaimer

The information presented in this document is for reference only. GuangDong Youfeng Microelectronics Co.,Ltd. reserves the right to make changes without notice for the specification of the products displayed herein to improve reliability, function or design or otherwise. The product listed herein is designed to be used with ordinary electronic equipment or devices, and not designed to be used with equipment or devices which require high level of reliability and the malfunction of with would directly endanger human life (such as medical instruments, transportation equipment, aerospace machinery, nuclear-reactor controllers, fuel controllers and other safety devices),YFW or anyone on its behalf, assumes no responsibility or liability for any damages resulting from such improper use of sale. This publication supersedes & replaces all information previously supplied. For additional information, please visit our website <https://www.yfwdiode.com>, or consult YFW sales office for further assistance.