

NPN Audio and General purpose Amplifier

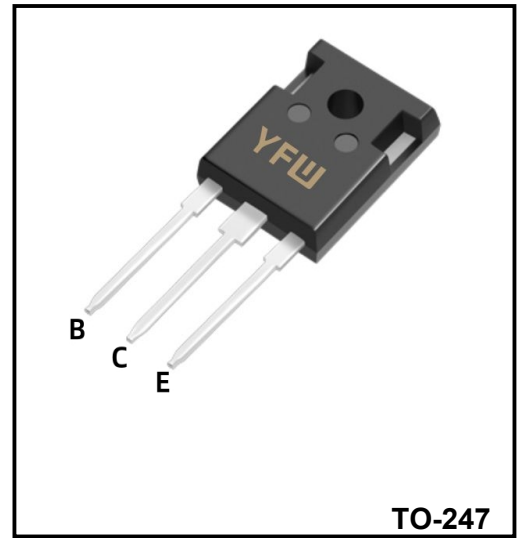

Features

- High collector-base breakdown voltage
- High DC current gain
- Complement to type 2SA1694

Absolute Maximum Rating (T_c=25°C)

Parameter		Symbol	Value	Unit
Collector-Base Voltage		BV_{CBO}	160	V
Collector-Emitter Voltage		BV_{CEO}	120	V
Emitter-Base Voltage		BV_{EBO}	6	V
Collector Current		I_C	8	A
Base Current		I_B	3	A
Power Dissipation	$T_A=25^{\circ}C$	P_D	3.5	W
	$T_C=25^{\circ}C$		80	
Junction Temperature		T_j	150	°C
Storage Temperature		T_{stg}	-40~150	°C

Note: Absolute maximum ratings are those values beyond which the device could be permanently damaged.
Absolute maximum ratings are stress ratings only and functional device operation is not implied.

Electrical Characteristics (Ta=25°C)

Parameter	Symbol	Conditions	Value			Unit
			Min	Typ	Max	
Collector-base breakdown voltage	BV_{CBO}	$I_C = 1mA, I_E = 0$	160			V
Collector-emitter breakdown voltage	BV_{CEO}	$I_C = 50mA, I_B = 0$	120			V
Emitter-base breakdown voltage	BV_{EBO}	$I_E = 1mA, I_C = 0$	6			V
Collector cut-off current	I_{CBO}	$V_{CB} = 120V, I_E = 0$			10	μA
Emitter cut-off current	I_{EBO}	$V_{EB} = 6V, I_C = 0$			10	μA
DC current gain	h_{FE}	$V_{CE} = 4V, I_C = 3A$	50		180	
Collector-emitter saturation voltage	$V_{CE(sat)}$	$I_C = 3A, I_B = 0.3A$			1.5	V
Base-emitter on voltage	$V_{BE(sat)}$	$I_C = 3A, I_B = 0.3A$			2.5	V
Transition frequency	f_T	$V_{CE} = 12V, I_C = 0.5A, f = 1MHz$		20		MHz
Output Capacitance	C_{ob}	$V_{CB} = 10V, I_E = 0, f = 1MHz$		200		pF
Turn-on Time	t_{ON}	$V_C = 40V, I_C = 4A, I_{B1} = I_{B2} = 0.4A, R_L = 10\Omega$		0.13		μS
Switching Time	t_S			3.5		μS
Fall Time	t_F			0.32		μS

*Pulse Test: Pulse Width = 300 μs , Duty Cycle = 2%

 h_{FE} Classification

Clas	2SC4467-O	2SC4467-P	2SC4467-Y
Range	50~100	70~140	90~180

Typical Characteristics

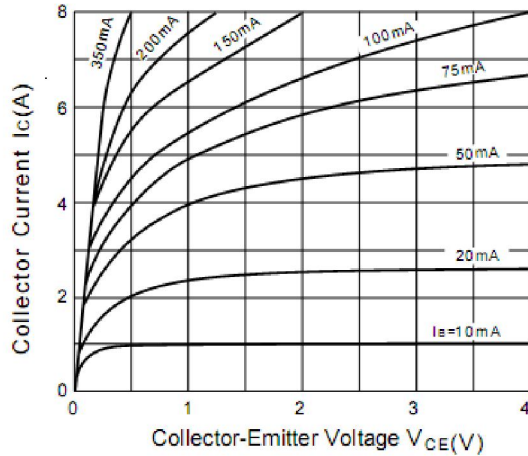

Figure 1. Static Characteristic

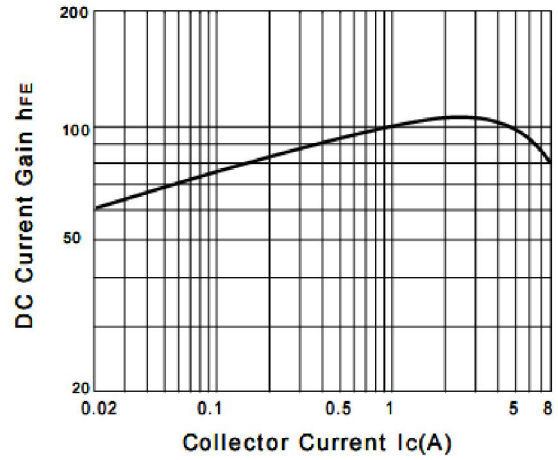

Figure 2. DC current Gain

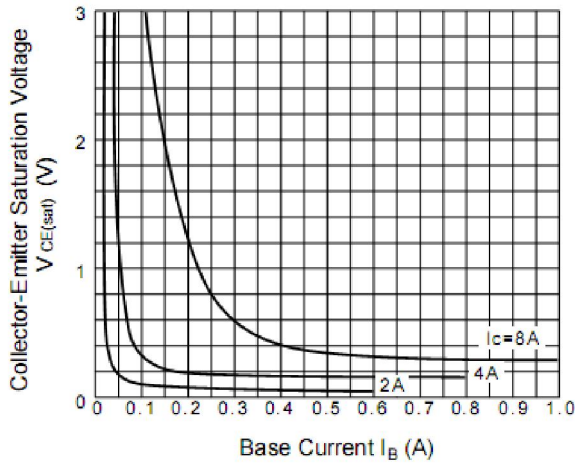

Figure 3. Saturation Voltage

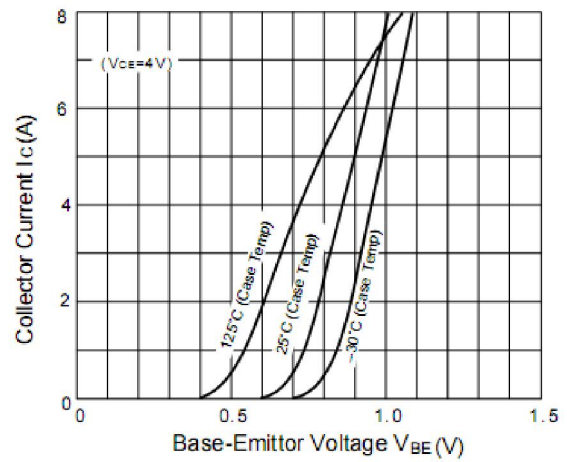

Figure 4. I_c - V_{BE} Temperature Characteristics

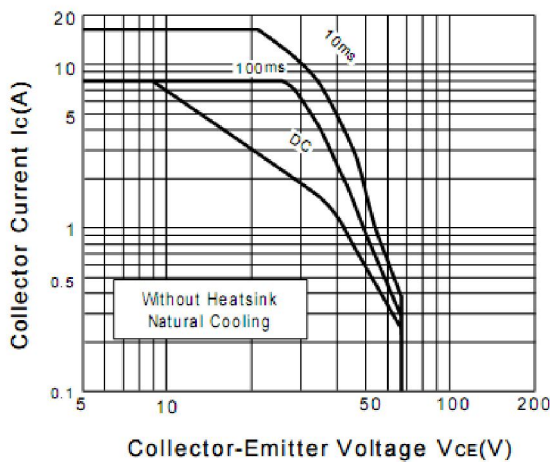

Figure 5. Safe Operating Area

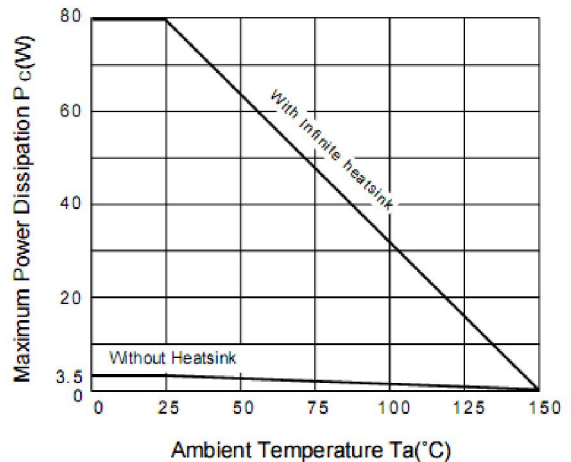
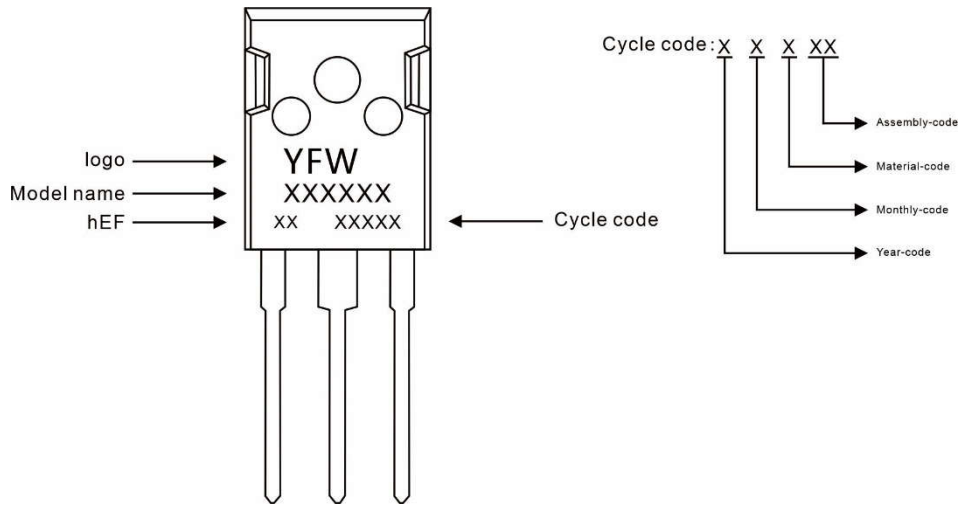

Figure 6. Power Derating

Marking Diagram



Ordering information

Model name	Package	Unit Weight	Base Quantity	Packing Quantity
2SC4467	TO-247	0.209oz(5.93g)	30pcs/tube	600PCS/Box 2400PCS/Carton

Package Dimensions

TO-247

Symbol	Dimensions in mm		Dimensions in Inch	
	Min.	Max.	Min.	Max.
A	4.90	5.10	0.193	0.201
A1	1.90	2.10	0.075	0.083
A2	2.29	2.54	0.090	0.100
b	1.00	1.40	0.039	0.055
b1	2.00	2.20	0.079	0.087
b2	3.00	3.20	0.118	0.126
c	0.50	0.70	0.020	0.028
D	15.75	16.05	0.620	0.632
E	20.20	20.80	0.795	0.819
e	5.45 (BSC)		0.215 (BSC)	
e1	10.90 (BSC)		0.429 (BSC)	
F	6.05	6.25	0.238	0.246
F1	5.80	6.00	0.228	0.236
L	20.10	20.40	0.791	0.803
L1	4.05	4.35	0.159	0.171
Φ	3.50	3.70	0.138	0.146

Disclaimer

The information presented in this document is for reference only. GuangDong Youfeng Microelectronics Co.,Ltd. reserves the right to make changes without notice for the specification of the products displayed herein to improve reliability, function or design or otherwise. The product listed herein is designed to be used with ordinary electronic equipment or devices, and not designed to be used with equipment or devices which require high level of reliability and the malfunction of with would directly endanger human life (such as medical instruments, transportation equipment, aerospace machinery, nuclear-reactor controllers, fuel controllers and other safety devices),YFW or anyone on its behalf, assumes no responsibility or liability for any damages resulting from such improper use of sale. This publication supersedes & replaces all information previously supplied. For additional information, please visit our website <https://www.yfwdiode.com>, or consult YFW sales office for further assistance.